



FINITURA E FISSAGGIO

1 Rivestimento in alluminio RAL

Rivestimento in alluminio è disponibile in tutte le colorazioni ral, nelle finiture lucida o opaca.

2 Coibentazione EPS (CAM)

EPS conforme alla percentuale di riciclato prevista dai CAM, con un valore di conducibilità termica pari a 0.034 W/m²k

3 Testa

4 Rompigoccia

TERMOGRAFIE

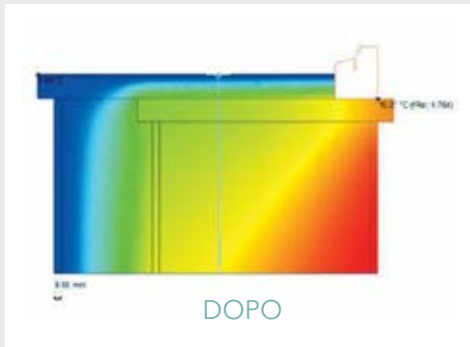
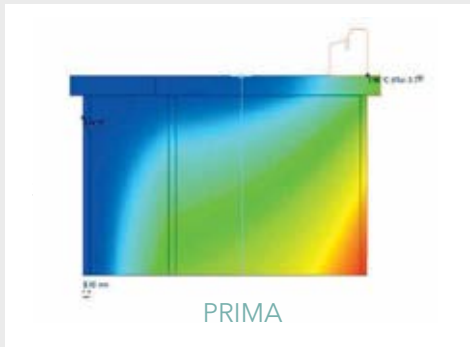

STAFFA REGGIDAVANZALE

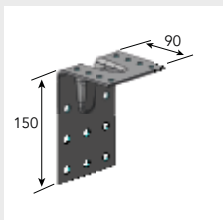

Staffa reggidavanzale da 90 mm

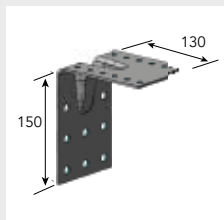

Staffa reggidavanzale da 130 mm

COVER

IL DAVANZALE D'AVANGUARDIA

SALVACALDO FILO MURO

PROFILO LINEARE

SPORGENTE PROFILO A "T"

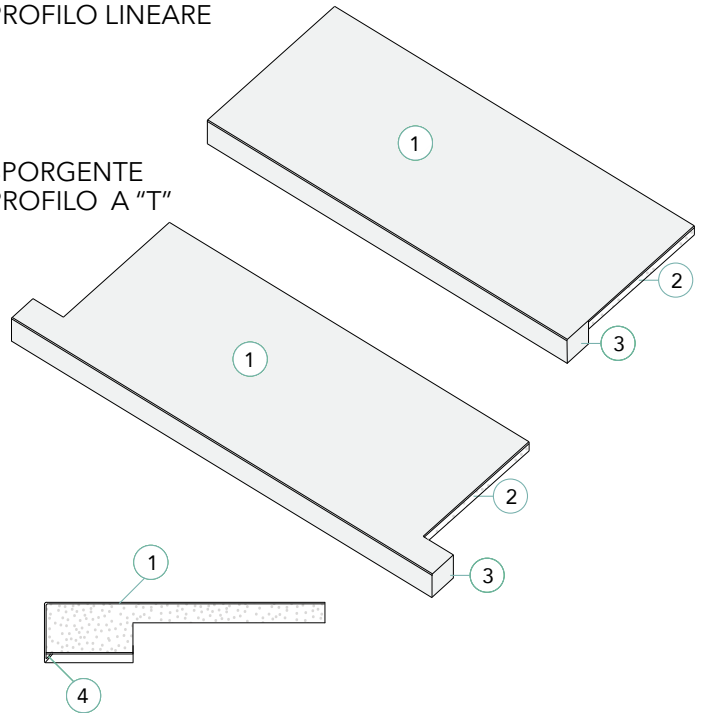

SEZIONE

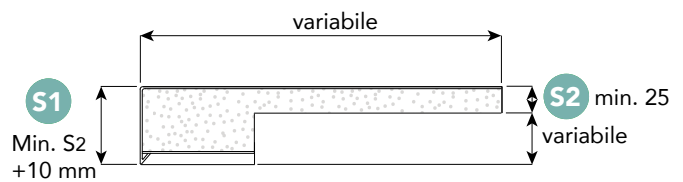

PIANTA

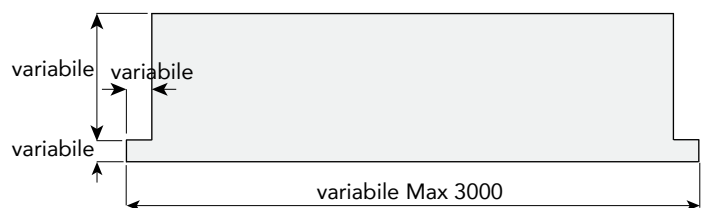

SEZIONE VERTICALE

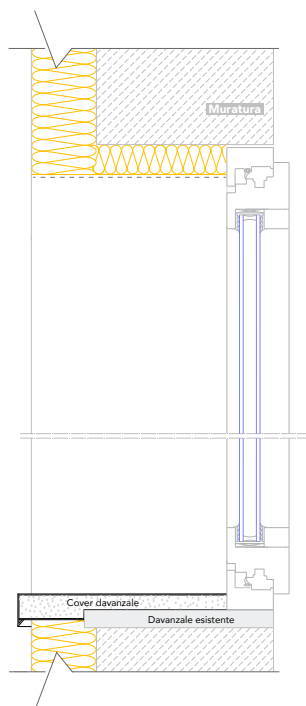

PROSPETTO ESTERNO

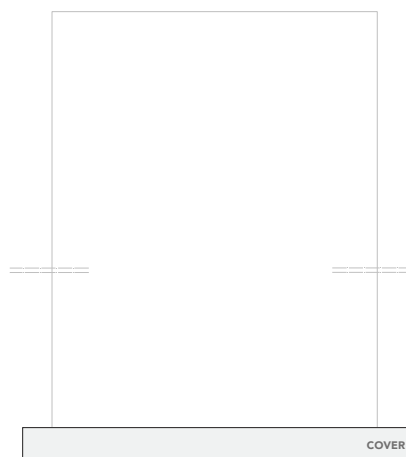

SEZIONE ORIZZONTALE

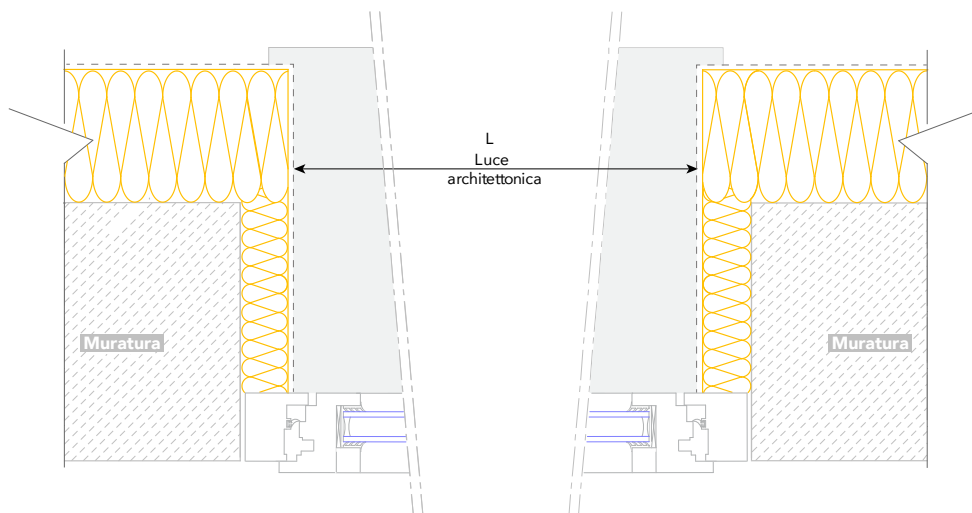

COLORI

RAL STANDARD OPACHI



RAL STANDARD LUCIDI



RAL FUORI STANDARD

