

GENERAZIONI DI SCALE

Generations of staircases



fontanot®



LUXURY WINDOWS
I T A L I A

GENERAZIONI DI SCALE

Generations of staircases



Ho cominciato a produrre scale per interni negli anni '70.

Quando sono "entrato" nel mondo ancora inesplorato delle scale, non avevo modelli a cui riportarmi. All'artigiano si chiedeva solo un "oggetto", una soluzione funzionale, che permettesse di accedere ad un piano superiore o inferiore.

La trasformazione di un "servizio" in un "prodotto" diventò il mio obiettivo.

La scala doveva essere industrializzata. Quello che ho sempre cercato e a cui tuttora tendo, è di andare sempre un po' più avanti, guardando verso il futuro.

I began producing staircases for interiors in the 1970s. When I "entered" the as yet unexplored world of staircases I had no models of reference. Artisans were simply asked for an "object", a functional solution that enabled people to access an upper or lower floor. My goal became that of transforming a "service" into a "product". Staircases needed to be industrialised. What I have always sought to do is to go that step further, looking towards the future.

A handwritten signature in dark ink on a light-colored rectangular background. The signature reads "Enzo Fontanot" in a cursive, slightly stylized script.

WELCOME TO THE FONTANOT HOME



**“Il primo incontro con
le scale in realtà è stato
l’incontro con una donna”**

Così esordisce il Fondatore, Enzo Fontanot.

Una prospettiva certamente romantica per un primo passo – anzi, un primo gradino – verso un successo internazionale. Una famiglia che si fa azienda, un’azienda che è e rimane famiglia. Il testimone è nelle mani dei figli: Francesco, Michele e Laura, tre personalità diverse per tre grandi professionisti.

Le scale: una scelta o un destino?

Francesco: Penso che il business familiare sia sempre stato appassionante per tutti e tre, altrimenti avremmo fatto altro.

Ma cosa vi sarebbe piaciuto fare... a parte le scale?

Francesco: L’atleta. Da ragazzo ero stato tesserato in una squadra di basket di categoria A1! E ora mi sto dedicando al triathlon.

Michele: Avrei voluto essere il braccio destro di Renzo Piano (ride).

My first experience with staircases was actually a meeting with a woman”. So begins founder Enzo Fontanot “ An undeniably romantic perspective for what was a first step towards international success.

A family that became a company, a company that is, and remains, a family. The baton has been passed onto his children: Francesco, Michele and Laura, three different personalities, three exemplary professionals.

Staircases: choice or destiny?

Francesco: I think all three of us have always been passionate about the family business, otherwise we would have followed different paths.

But aside from staircases what else would you have liked to have been?

Francesco: A sportsman. When I was younger I played basketball at quite a high level. Now I am very in to the triathlon.



La scala di Laura è una Scenik senza ringhiera
Laura's staircase is a Scenik with no railing

Laura: La scenografa, l'artista o l'arredatrice d'interni.

I vostri giochi lasciavano trasparire qualche inclinazione al design?

Michele: Di noi ragazzi non saprei dire ma ricordo Laura che giocava con la sua casa di Barbie. In realtà, non le importava la bambola in sé ma l'ambiente in cui era inserita, da costruire e arredare. Oggi ritrovo questa attitudine in mia figlia: ama le costruzioni Lego, le abbiamo sparse per tutta la casa.

La creatività e l'arte della progettazione sono nel vostro sangue, si direbbe. Cosa avete studiato?

Francesco: Economia, a cui è seguito subito l'ingresso in azienda.

Michele: Architettura, avevo le idee molto chiare su cosa volevo diventare in azienda.

Laura: Scenografia, ricordo ancora la mia tesi sui richiami cinematografici alla Pop-Art e a Warhol.

Sono stati gli studi a condurvi al vostro attuale ruolo in azienda? O solo il carattere?

Francesco: Un mix direi, diventare Responsabile dell'area

Michele: I would like to have been Renzo Piano's right-hand man (laughs).

Laura: A set designer, artist or interior decorator.

Did your toys hint at any inclination towards design?

Michele: I couldn't really comment for myself and Francesco but I remember Laura playing with her Barbie house. In reality, it was not so much the doll that interested her but her home, which she would build and decorate. Now I can see that my daughter shares this same interest: she loves playing with Lego, which is scattered all over the house.

You might say that creativity and the art of design is in your blood. What did you study?

Francesco: Economics, immediately after which I joined the company.

Michele: Architecture. I had a very clear idea of what I wanted to become in the company.

Laura: Set Design. I still remember my thesis on cinematographic references to Pop Art and Warhol.

Did your studies lead you towards your current role in the

Commerciale e poi Presidente significa essere un uomo di numeri.

Michele: Entrambe le cose, tant'è che ora sono Project Manager. Gli studi di Architettura non sarebbero bastati, senza una grande curiosità e creatività di fondo.

Laura: È stato mio padre a spingermi in quello che adesso è il mio ruolo in azienda di Direttrice delle Comunicazioni e ci ha visto lungo: a volte i genitori ci conoscono meglio di quanto pensiamo.

Parlando di carattere, Francesco e Michele: dite un pregio e un difetto di Laura... siate sinceri!

Francesco: Al contrario di me, che pondero sempre ogni variabile e ragiono in modo super-razionale, Laura spesso prende le decisioni d'istinto. E la cosa grandiosa è che molto spesso ha ragione!

Michele: Ha grandi doti relazionali e le invidio la capacità di vedere sempre il lato positivo delle cose. A volte ci si scontra proprio per questo.

I tuoi fratelli sono stati "teneri" nel giudizio. E tu, Laura, cosa pensi di loro?

Laura: Francesco è un fratello concreto, deciso, solido, sembra che sappia sempre ciò che è meglio fare.

Michele è propositivo. Un difetto di entrambi? Sono testardi oltre misura e se lo "rinfacciano" a vicenda!

E di Enzo, vostro padre, cosa pensate? Descrivetelo in poche parole.

Francesco: Un uomo al passo con i tempi. È sempre aggiornato sul mercato e a volte mi stupisce con le sue intuizioni geniali, assolutamente all'avanguardia.

Michele: Data la sua immensa passione per il mare, direi che è un capitano. Sa sempre darci la direttiva giusta al momento opportuno.

Laura: Mio padre? Un lupo solitario. È anche un uomo magnetico, dalla forte personalità. Ricordo che, quando ero ragazzina, tutte le mie amiche ne rimanevano affascinate (sorride).

Parlate mai di scale la domenica a pranzo? Francesco: Poche volte. Anche perché, altrimenti, sarebbe un litigio continuo!



company? Or was it more down to your character?

Francesco: A mix I'd say. Becoming Head of Sales and then Chairman suggests that I'm a numbers man.

Michele: Both, as my role of Project Manager suggests. Without my natural inquisitiveness and creativity, my architecture background wouldn't have been enough on its own.

Laura: It was my father that pushed me towards my role in the company as Director of Communications, an inkling that showed great foresight: sometimes our parents know us better than we think.

Speaking of character, Francesco and Michele: describe one of Laura's virtues and one of her flaws... and be honest!

Francesco: Unlike me, who always ponders every variable and reasons in an ultra-rational way, Laura is often more instinctive. And the great thing is that she is very often right!

Michele: She has great interpersonal skills and I admire her ability to always see the positive in everything. Sometimes we clash for this very reason.

Your brothers were very kind about you. What do you think of them, Laura?

Laura: Francesco is a dependable, decisive and solid brother, he always seems to know what the best course of action is.

Michele has a constructive attitude. A flaw they both have? They are unbelievably stubborn and rub each other up the wrong way!

And what would you say about your father, Enzo? Describe him in a few words.

Francesco: A man that moves with the times. He always knows what is going on in the market and sometimes he surprises me with his ingenious cutting-edge intuition.



Scala modello LaFont per la casa "minimale" di Michele
A LaFont staircase for Michele's "minimalist" home

Se foste una scala, quale sareste?

Francesco: Questa è difficile! Direi una Xilo: ora è fuori produzione ma mi è sempre piaciuta perché un po' mi somiglia. Aveva linee pulite e semplici, costruita in solido legno con finitura laccata lucida.

Michele: Sono un tipo minimale, ecco perché ho scelto una LaFont per casa mia: senza fronzoli e nemmeno viti a vista.

Laura: Quando ho strutturato casa, se fosse esistita avrei senza dubbio scelto una Techne. È la nostra scala più innovativa e tecnologica: è realizzata con un polimero plastico assolutamente futuristico, è stata una sfida incredibile dal punto di vista dei materiali e del design.

Trovate che le case dei vostri fratelli siano in linea con la loro personalità?

Francesco: La casa di Michele gli somiglia.

È minimale, tutta giocata sul contrasto bianco-nero, sulle superfici lucide, sul vetro... ma non pensiate che sia fredda, proprio come non lo è lui.

“Mio fratello è una persona conviviale. In cucina campeggiano un enorme tavolo con una dozzina di sedie e una fornitissima cantina di vini.”

Michele: Laura è una persona poliedrica e la sua casa non poteva essere altrimenti. Un mix di stili diversi: sa accostare un tavolo inglese del '700 con un divano di design anni '70 e un Campari Light. E nonostante questo, l'insieme risulta



Michele: Given his immense passion for the sea I'd say that he is a captain. He always knows how and when to steer us in the right direction.

Laura: My father? A lone wolf. He is also a magnetic man with a strong personality. When I was growing up all my girlfriends were very taken with him (smiles).

Do you ever talk about staircases at Sunday lunch?



Francesco: Not very often. Also because it would just be one long squabble otherwise! (laughs)

If you were a staircase what type would you be?

Francesco: That's a difficult one! I'd say a Xilo: it's no longer in production but I always liked it because it is quite similar to me. It had clean and simple lines and was made from solid wood with a glossy lacquered finish.

Michele: I am quite a simple person, that's why I chose a LaFont for my home: no frills and not even any visible screws.

Laura: When I built my house, I would definitely have chosen a Techne if it had existed then. It is our most innovative and technological staircase, made from a truly futuristic plastic polymer. A real challenge from a material and design perspective.

Do you think your siblings' homes reflect their personalities?

Francesco: Michele's home resembles him. It is minimalist and dominated by the contrast between black and white, by polished surfaces and glass...but just like him, it isn't at all cold. My brother is a very sociable person. In the kitchen there is a huge table with a dozen chairs and a very well-stocked

omogeneo e sobrio, senza eccessi.

Laura: La casa di Francesco è elegante e al contempo giocosa, come lui. Nella zona living saltano all'occhio alcuni dettagli: una scultura di motocicletta in carta e un quadro di Schifano, simboli di alcuni lati più "ribelli" della sua personalità in apparenza più razionale.

Quale vostra caratteristica dominante ritenete di mettere nel lavoro?

Francesco: La Passione.

Michele: La Sperimentazione.

Laura: La Creatività.

“Passione, sperimentazione e creatività, ma anche studio attento, gusto per il design, intuizioni geniali, senso del mercato: perché per Fontanot le scale sono “affari di famiglia”.”



Una scala “tecnica”, modello Techne, per Francesco, lo sportivo della famiglia.
A Techne “technical” staircase for Francesco, the sportsman of the family.



wine cellar.

Michele: Laura is a very eclectic person and her home is no different. It is a mix of different styles: she knows how to combine an 18th century English table with a 1970s designer sofa and a Campari Light. And despite this the overall effect is homogeneous and understated, with no extremes.

Laura: Francesco's home is both elegant and playful, just like him. A few details in the living-room catch the eye: a paper sculpture of a motorbike and a Schifano painting, which symbolise the more “rebellious” side of a person who appears to be more rational on the surface.

Which of your dominant character traits do you think you put into your work?

Francesco: My passion.

Michele: Experimentation.

Laura: Creativity.

Passion, experimentation and creativity, but also painstaking study, a taste for design, ingenious intuition, and good business sense: because for Fontanot staircases are a “family affair”.





SCEGLI LA TUA SCALA

CHOOSE YOUR STAIRCASE

- 15. **Innovative**
 INNOVAZIONE DI PROGETTO E DI DESIGN
 Project and Design Innovation

Rampe **R**/ Chiocciole **T - Q**
 Winder **R**/Spiral **T - Q**
- 25. **Prestige**
 LA COLLEZIONE PIÙ PRESTIGIOSA
 The most prestigious collection

Rampe **R**/ Chiocciole **T - Q**
 Winder **R**/Spiral **T - Q**
- 71. **Contemporary**
 SOLUZIONI UNICHE PER OGNI STILE
 Unique solutions for any style

Rampe **R**/ Chiocciole **T - Q**
 Winder **R**/Spiral **T - Q**
- 101. **Classic**
 CLASSICO, INTRAMONTABILE
 Classic, timeless

Rampe **R**/ Chiocciole **T - Q**/Salvaspazio
 Winder **R**/Spiral **T - Q**/Spacesaver
- 111. **Young**
 GIOVANE, SMART, PER TUTTI
 Young, smart, for everyone

Rampe **R**/ Chiocciole **T - Q**/Salvaspazio
 Winder **R**/Spiral **T - Q**/ Spacesaver

ALTRE INFORMAZIONI

OTHER INFORMATION



- 12.
and the winner is... fontanot
eco-design Fontanot/certificazioni/certifications
- 129.
sottogrado/riser
pannello di protezione/safety panel
- 131.
dettagli/details
- 133-135.
rovere e frassino/oak and ash 
- 137.
tinte/shades
- 141.
colori/colours
- 145.
servizi/services
- 147.
tabella riassuntiva/
summary table

AND THE WINNER IS... FONTANOT



Nel corso degli anni Fontanot ha vinto importanti premi e riconoscimenti nazionali e internazionali:

'XNODO'

1983 Primo Premio al concorso "Premio Saiedue" di Bologna e Primo Premio al concorso "Diploma Biennial of Industrial DesignBio10" di Lubiana

La prima rivoluzionaria scala in acciaio e poliuretano caratterizzata da una struttura costituita da una serie di elementi regolabili in senso orizzontale;

'AMIKA'

1990 Primo Premio al concorso "International Contemporary Furniture" di New York e 1992 Primo Premio al concorso "Tecnologia e Forma" International Design Management di Milano

La scala completamente regolabile grazie a un semplice meccanismo presente su ogni singolo supporto.

Over the years Fontanot has won important national and international awards and prizes: 1983 First Prize in the Bologna "Premio Saiedue" competition and First Prize in the Ljubljana "Diploma Biennial of Industrial DesignBio10" competition for the XNODO, the first revolutionary steel and polyurethane staircase distinctive for its structure made up of a series of horizontally adjustable elements;

1990 First Prize in the "International Contemporary Furniture" competition in New York and 1992 First Prize in the "Tecnologia e Forma" International Design Management competition of Milan for AMIKA, the staircase that is completely adjustable thanks to a simple mechanism on every support.

ECO-DESIGN FONTANOT

L'attenzione all'ambiente è uno dei valori più importanti per Fontanot, che progetta le sue scale tenendo conto dell'intero ciclo di vita del prodotto: in fase di produzione vengono usati prodotti eco-compatibili e privi di sostanze nocive e i materiali di scarto sono trasformati in combustibile per il riscaldamento aziendale.

Tre le certificazioni che confermano il lato "green" di Fontanot:

ETICHETTA A+ indica il grado più basso di emissione di sostanze nocive, a salvaguardia della qualità dell'aria e degli ambienti;

FSC® (Forest Stewardship Council® - FSC.org) è il marchio internazionale che assicura la provenienza del legno da foreste gestite in modo responsabile;

CSQ ISO 9001:2008 e **IQNet** sono il risultato concreto di una organizzazione efficace e scrupolosa.



The importance of the environment is a key issue for Fontanot which designs its staircases taking into account the entire life cycle of the product: eco-compatible products free of harmful substances are used during the production phase and scrap materials are transformed into fuel to heat the company premises.

Three certifications confirm Fontanot's "green" nature:

The A+ LABEL indicates the lowest emission level of toxic substances to safeguard indoor air quality.

FSC® (Forest Stewardship Council® - FSC.org) is the international trademark that guarantees that the wood originates from responsibly managed forests.

CSQ ISO 9001:2008 and IQNet are the tangible results of an effective and scrupulous organisation.

**100%
riciclabile**
100% recyclable



**Progetto
Zero
Waste**

Fontanot ha ideato la prima "guida" per convertire le sue casse di imballaggio di legno in originali oggetti di design: una panchina in cui parcheggiare la bicicletta, un giardino urbano o una scarpiera in cui sedersi e riporre scarpe. Il legno si reinventa rivestendo forme nuove.

Zero Waste project

Fontanot invented the first "guide" to converting its wood packing crates into original design objects: a bench where you can park your bicycle, an urban garden or a shoe rack you can sit on and store shoes. Wood reinvents itself taking new forms.

DIVA.

*La scala modulare
oltre le regole*

The modular staircase
that goes beyond the rules



2019
PRODOTTO DELL'ANNO
product of the year

Diva

corrimano, colonnine, struttura e elementi orizzontali acciaio
inox AISI 304 lucido - gradini in marmo colore grigio
(a campione) - scala a progetto/
*polished AISI 304 stainless steel handrail, balusters,
structure and horizontal elements - grey marble treads
(sample colour) - custom-designed staircase*



2019_
PRODOTTO DELL'ANNO
product of the year

Diva 060 bx

corrimano, colonnine doppio piatto e elementi orizzontali acciaio inox AISI 304 lucido -
struttura acciaio verniciato nero lucido (a campione) - gradini gres color cioccolato -
scala a progetto/
polished AISI 304 stainless steel handrail, double balusters and horizontal elements -
polished black steel painted structure (sample colour) - chocolate coloured stoneware tile
- custom-designed staircase

DIVA.
Elegante e scultorea

Elegant and sculptural



2019
PRODOTTO DELL'ANNO
product of the year

Diva 090

struttura acciaio verniciato bianco RAL 9010 lucido
(a campione) - gradini legno di recupero, faggio -
pannelli vetro chiaro/
*polished white RAL 9010 painted steel structure (sample
colour) - recycled beech wood treads - clear glass panels*

IN&OUT INDUSTRIAL CHIC

In&Out Industrial Chic



2008_
selezionata da "Adi Index"
selected by "Adi Index"



100% Recyclable

Techne t 030

colonnine acciaio verniciato e struttura tecnopolimero
colore verde RAL 6011/
green RAL 6011 painted steel balusters
and technopolymer structure

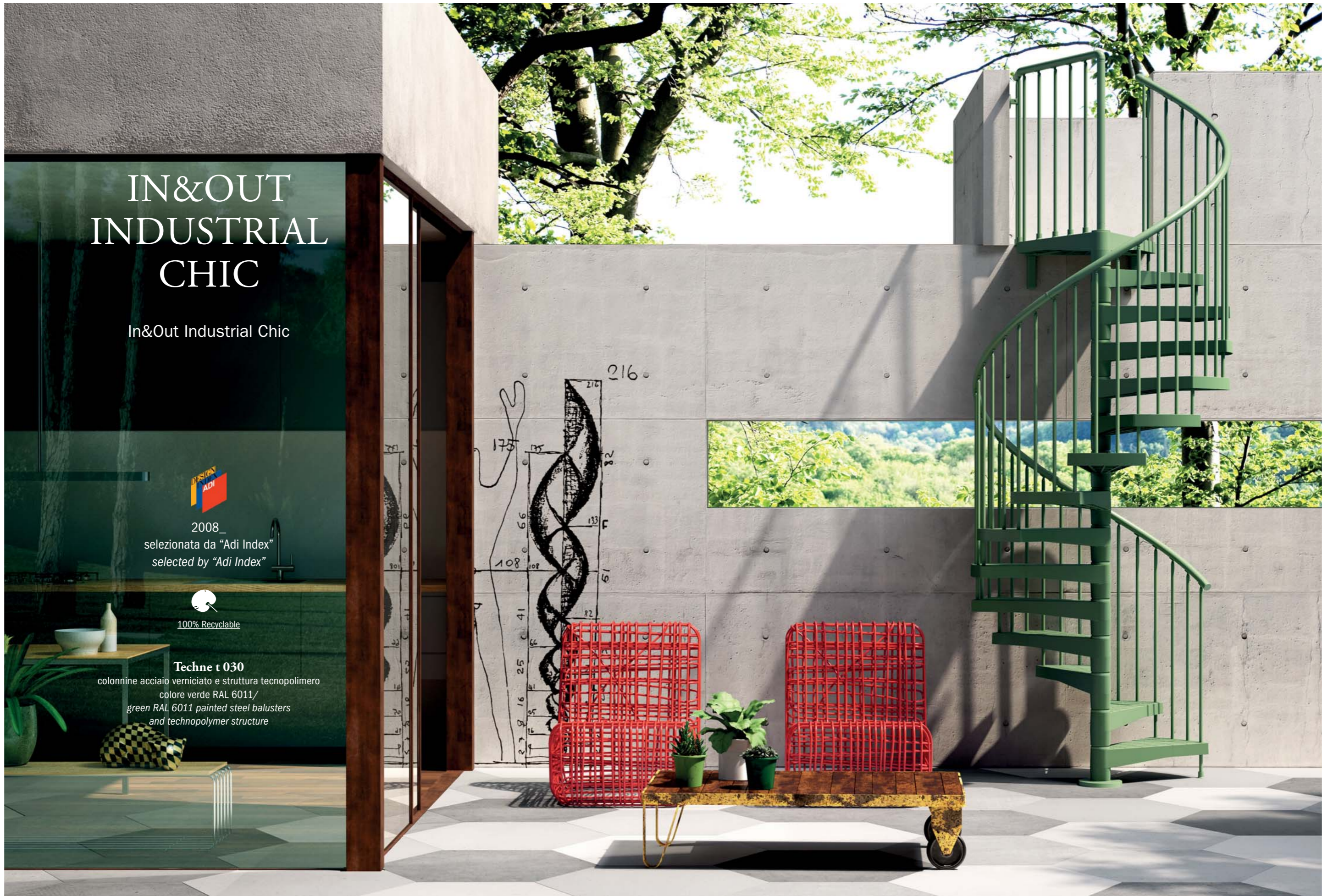



Minimized t

struttura e gradini acciaio verniciato bianco ghiaccio RAL 9003 - scala a progetto/
cool white RAL 9003 painted steel structure and treads - custom-designed staircase



Twist

cosciale e colonnine acciaio verniciato corten - gradini rovere tinta naturale - corrimano ed elementi orizzontali acciaio inox AISI 304 satinato - scala a progetto / corten-coloured painted steel side and balusters - natural oak treads - satin AISI 304 stainless steel handrail and horizontal elements - custom-designed staircase



LaFont lastra t 050 b

corrimano, colonnine ed elementi orizzontali acciaio inox AISI 304 satinato - gradini acciaio verniciato nero RAL 9004/ *satin AISI 304 stainless steel handrail, balusters and horizontal elements - black RAL 9004 painted steel treads*



LaFont spira t 060 c

corrimano, colonnine, struttura ed elementi orizzontali acciaio inox AISI 304 satinato - gradini vetro carminio/
satin AISI 304 stainless steel handrail, balusters, structure and horizontal elements - carmine red glass treads

CAMMINARE NEL VUOTO

Walking on air

LaFont spira t 060 c

Il vetro dei gradini, dettaglio unico per una scala a chiocciola,
può essere personalizzato con colorazioni diverse,
per accordarsi con l'ambiente e la vostra personalità.
*The glass of the treads, a unique detail for a spiral staircase,
can be customised with different colours in order to fit
the setting and your personality.*

gradini vetro fango/
mud brown-coloured glass treads

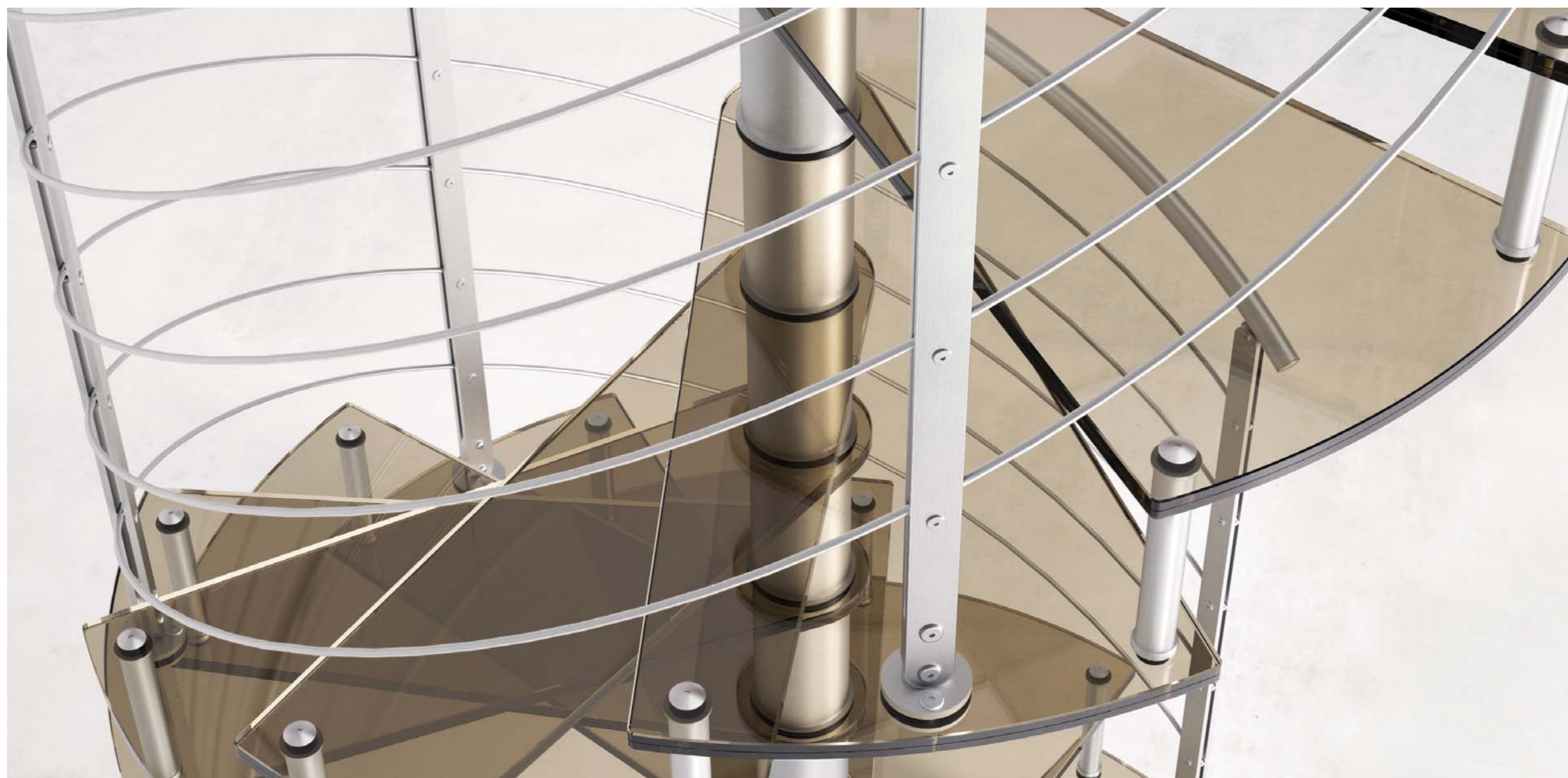



Wall

gradini faggio tinta noce scuro - scala a progetto/
dark walnut beech treads - custom-designed staircase



Wall 060 b

colonnine acciaio verniciato grigio ghisa - struttura acciaio verniciato bianco RAL 9010- gradini frassino tinta noce scuro - corrimano ed elementi orizzontali acciaio inox AISI 304 satinato/ iron grey painted steel balusters - white RAL 9010 painted steel structure - dark walnut ash treads - satin AISI 304 stainless steel handrail and horizontal elements

SEMPRE WALL. ANCHE SCALA

Still Wall. Also staircase



Wall 090 a

struttura acciaio verniciato bianco RAL 9010 - gradini rovere tinta naturale - pannelli vetro extra chiaro/ white RAL 9010 painted steel
structure - natural oak treads - extra clear glass panels

VEDO, NON VEDO

Now you see me,
now you don't



Gradini con rotules a vista per chi ama i contrasti delle finiture
o ricoperti con carter per chi sceglie l'essenziale.

*Treads with visible joints for those who love contrasting
finishes or with a cover for those who choose the essential.*

gradini rovere tinta naturale - pannelli vetro chiaro
natural oak treads - clear glass panels





LaFont fascia r 090

cosciale lato esterno acciaio inox AISI 304 satinato - lato interno acciaio verniciato violetto (a campione)
- gradini acciaio verniciato bianco ghiaccio RAL 9003 - pannelli vetro extra chiaro - scala a progetto/
satin AISI 304 stainless steel exterior side - violet (sample colour) painted steel interior side - cool white
RAL 9003 painted steel treads - extra clear glass - custom-designed staircase



DOPPIO SOGNO

Double dream

LaFont fascia r 090

I cosciali e i gradini sono disponibili in soluzioni bicolori,
per massimizzare la possibilità di personalizzazione.
*The sides and the treads are available in two-tone solutions
to maximise the scope for customisation.*

cosciale lato esterno acciaio inox AISI 304 satinato - lato interno acciaio verniciato violetto (a campione) - gradini acciaio verniciato bianco ghiaccio RAL 9003 - pannelli vetro extra chiaro - scala a progetto/ satin AISI 304 stainless steel exterior side - violet (sample colour) painted steel interior side - cool white RAL 9003 painted steel treads - extra clear glass - custom-designed staircase



LaFont fascia r 050 b

cosciale acciaio verniciato nero RAL 9004 - gradini rovere tinta naturale - elementi orizzontali acciaio inox AISI 304 satinato / black RAL 9004 painted steel side - natural oak treads - satin AISI 304 stainless steel horizontal elements



LaFont fulmine r 120 b

corrimano, colonnine, struttura ed elementi orizzontali acciaio al vivo (a campione) - gradini bamboo tinta naturale/
untreated steel handrail, balusters, structure and horizontal elements (personalized finish) - natural bamboo treads

ACCIAIO AL VIVO: ARMONIA DI CONTRASTI

Untreated steel:
harmony of contrasts

LaFont fulmine r 120 b

La luminosità dell'acciaio è accentuata dall'assenza di viti a vista.
The brightness of the steel is accentuated by the absence of visible screws.





LaFont fulmine r 120 c

struttura acciaio verniciato blu (a campione) - gradini rovere spazzolato tinta sbiancato - corrimano, colonnine ed elementi orizzontali acciaio inox AISI 304 satinato/ blue (sample colour) painted steel structure - bleached brushed oak treads - satin AISI 304 stainless steel handrail, balusters and horizontal elements



LaFont essential fulmine r 090 a

struttura acciaio verniciato grigio ghisa - gradini rovere tinta naturale - pannelli vetro
chiaro/ iron grey painted steel structure - natural oak treads - clear glass panels



LaFont essential fulmine r 050 b

corrimano, colonnine ed elementi orizzontali acciaio inox AISI 304 satinato - struttura acciaio verniciato bianco RAL 9010 - gradini faggio tinta tortora/ satin AISI 304 stainless steel handrail, balusters and horizontal elements - white RAL 9010 painted steel structure - dove grey beech treads

L'ESSENZIALE DALL'ALTRA PARTE DEL MARE

The essential
on the other side of the sea



LaFont essential fulmine r 120 a

corrimano, colonnine, struttura, gradini ed elementi orizzontali acciaio verniciato corten/
corten-coloured painted steel handrail, balusters, structure, treads and horizontal elements



LaFont essential fascia r 080

colonnine e struttura acciaio verniciato bianco RAL 9010 - gradini frassino tinta sbiancato
- pannelli metacrilato trasparente/ white RAL 9010 painted steel balusters and structure -
bleached ash treads - transparent methacrylate panels



LaFont essential fulmine r 120 a

corrimano, colonnine, struttura ed elementi orizzontali acciaio verniciato nero RAL 9005 - gradini faggio tinta avana scuro (a campione)/
black RAL 9005 painted steel handrail, balusters, structure and horizontal elements - dark havana beech treads (sample colour)



LaFont essential fascia r 060 b

colonnine e struttura acciaio verniciato colore corten - gradini faggio tinta noce biondo - corrimano e elementi orizzontali acciaio inox AISI 304 satinato / *corten coloured painted steel balusters and structure- blond walnut beech treads - satin AISI 304 stainless steel handrail and horizontal elements*

ORE 7.30: spazio ALLA PASSIONE

7.30 am: make room for passion

LaFont essential fascia r 060 bx

corrimano, colonnine ed elementi orizzontali acciaio inox AISI 304 satinato - struttura acciaio verniciato grigio RAL 9006 - gradini frassino tinta sbiancato/
satin AISI 304 stainless steel handrail, balusters and horizontal elements - grey RAL 9006 painted steel structure - bleached ash treads

NOTE ALLA SCALA

Notes at la Scala



LaFont essential fulmine r 020 b

corrimano, colonnine, struttura ed elementi orizzontali acciaio verniciato bianco RAL 9010 - gradini faggio tinta noce chiaro/
white RAL 9010 painted steel handrail, balusters, structure and horizontal elements - light walnut beech treads



LaFont essential fulmine r 020 a

corrimano, colonnine e struttura acciaio verniciato grigio RAL 9006 - gradini frassino tinta wengé (a campione) -
elementi orizzontali acciaio inox (dettaglio pag. 131) / grey RAL 9006 painted steel handrail, balusters and structure
- wenge (sample colour) ash treads -+ stainless steel horizontal elements (detail page 131)

STILE *industrial,*
caldo E CONVIVIALE

Warm and sociable industrial style



Slim t 030

colonnine e struttura acciaio verniciato corten - corrimano alluminio verniciato corten/
corten-coloured painted steel balusters and structure - corten-coloured painted aluminium handrail



TRENDY E SOSTENIBILE

Trendy and sustainable

Slim t 010 a

Gradini in legno di recupero: l'attenzione all'ambiente non è mai stata così chic.
Treads in recycled wood: being environmentally friendly has never been so chic.

colonnine e struttura acciaio verniciato bianco RAL 9010
corrimano alluminio verniciato bianco RAL 9010
gradini legno di recupero - elementi orizzontali acciaio inox AISI 304
*white RAL 9010 painted steel balusters and structure - white RAL 9010 painted aluminium handrail
recycled wood treads - AISI 304 stainless steel horizontal elements*

COPRE E SCOPRE OGNI GIORNO

Cover and uncover every day



Genius t 100 Skin

corrimano PVC estruso grigio RAL 7030 - colonnine e struttura acciaio verniciato grigio RAL 7030
gradini faggio tinta avana scuro (a campione) - tessuto plastico Skin Square/
grey RAL 7030 extruded PVC handrail - grey RAL 7030 painted steel balusters and structure
dark havana beech treads (sample colour) - Skin Square plastic fabric



Genius t 070

corrimano, colonnine, struttura e gradini faggio tinta sbiancato - fissaggi acciaio verniciato bianco RAL 9010/
bleached beech handrail, balusters, structure and treads - white RAL 9010 painted steel fixings



RELAX
TAKE IT 2:EASY

Relax, take it 2:Easy

Genius 2:Easy 030

corrimano, struttura e gradini frassino tinta naturale - colonnine acciaio verniciato cromo/
natural ash handrail, structure and treads - chrome painted steel balusters

INNOVATIVE
2:EASY SYSTEM
PIU COMODO
E SICURO

safer and more comfortable

GRADINO
 TRADIZIONALE

traditional tread

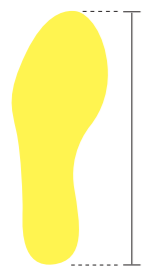
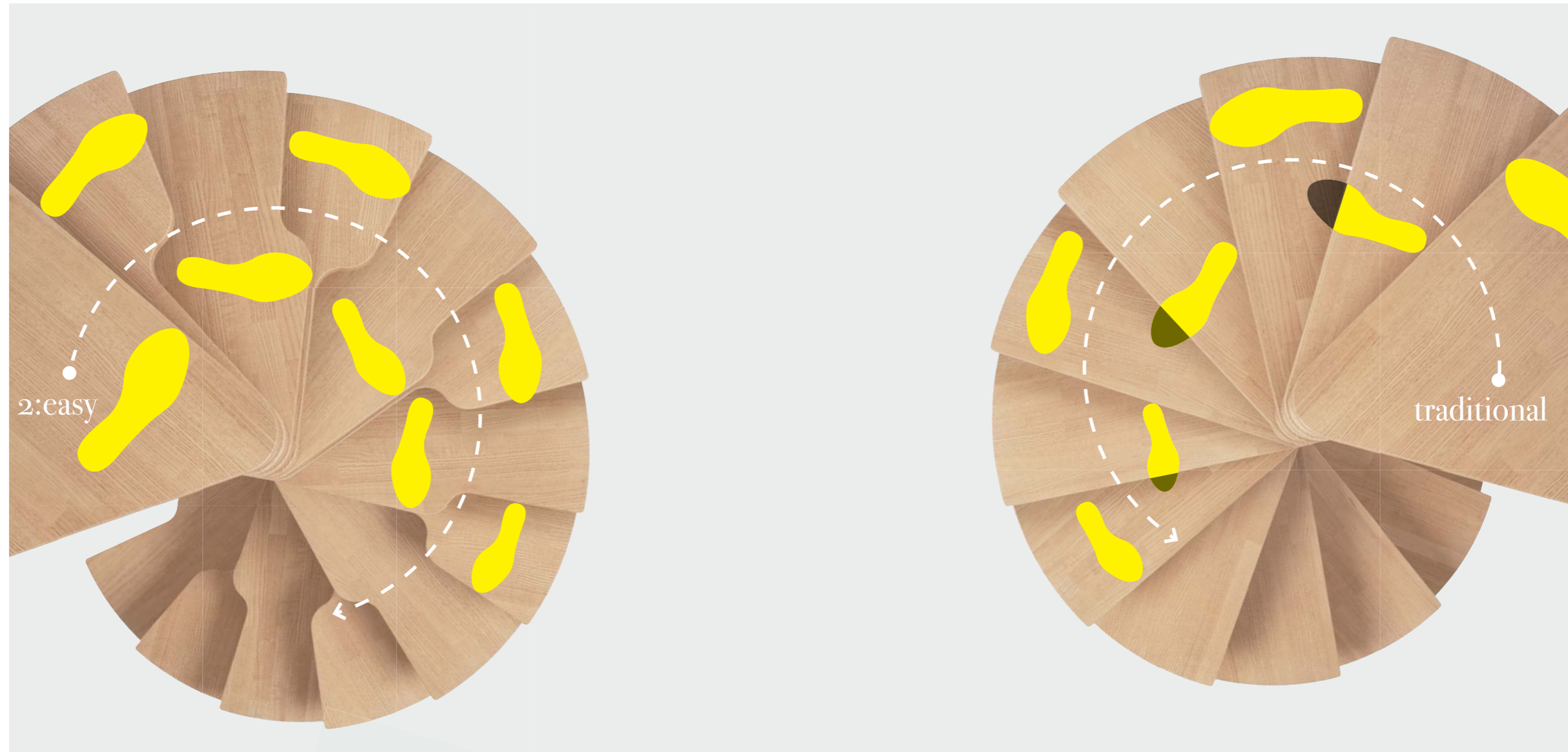

Appoggio
 pianta del piede
 in interno

foot sole
 bearing
 on the inside

2:easy

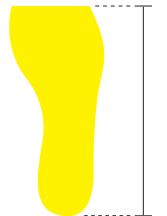

Appoggio
 pianta del piede
 in interno

foot sole
 bearing
 on the inside

traditional

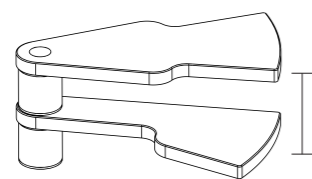

< 20cm

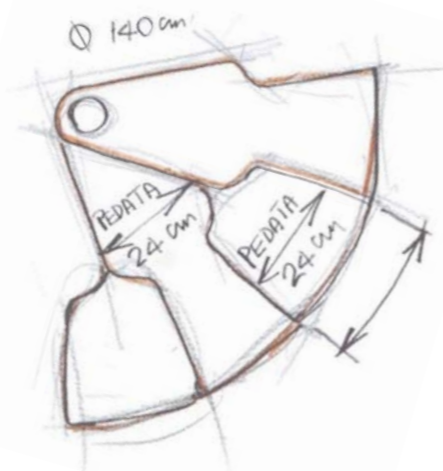

Rispetto alla scala a chiocciola tradizionale,
 l'alzata è più bassa di almeno 3 cm.
 Massima comodità e sicurezza in salita e in discesa.
 2:Easy System è un brevetto d'Invenzione
 (Patent Pending).

Compared to a conventional spiral staircase,
 the rise is at least 3 cm lower. Absolute comfort
 and safety when walking up and down the stairs.
 2:Easy System is a patented invention
 (Patent Pending).

> 20cm

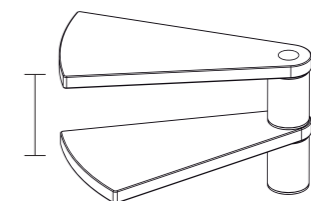

POESIA E PROSA *LEGNO E NICHEL:* ALLURE BOHÉMIENNE

Poetry and prose, wood and nickel: bohemian allure



Genius t 050 a

corrimano, struttura e gradini rovere tinta naturale - colonnine acciaio verniciato nichel satinato - elementi orizzontali acciaio inox/
natural oak handrail, structure and treads - satin nickel-plated painted steel balusters - stainless steel horizontal elements

TOCCARE
CON GLI OCCHI
GUARDARE
CON LE MANI

Touch with your eyes, look with your hands

Genius t 050



La cura dei dettagli e la purezza dei materiali rende questo corrimano e questa ringhiera unici. Le forme sinuose e i giunti dei tondini sono funzionali e di grande impatto estetico.
The attention to detail and the purity of the materials make this handrail and railing unique.

Sinuous forms and functional, high-impact bar joints.

corrimano frassino tinta avana scuro (a campione) - colonnine ed elementi orizzontali acciaio inox AISI 304 lucido/
dark havana ash handrail (sample colour) - polished AISI 304 stainless steel balusters and horizontal elements



Genius t 030 a

corrimano, struttura e gradini frassino tinta tortora - colonnine acciaio verniciato grigio RAL 7039 (a campione)/
dove grey ash handrail, structure and treads - grey RAL 7039 (sample colour) painted steel balusters



SCANDINAVIAN STYLE SIMPLY *chic!*

Simply chic scandinavian style



Genius t 020

corrimano e gradini faggio tinta naturale - colonnine e struttura acciaio verniciato bianco RAL 9010/
natural beech handrail and treads - white RAL 9010 painted steel balusters and structure



Genius q 050

corrimano, struttura e gradini frassino tinta naturale - colonnine ed elementi orizzontali
acciaio inox AISI 304 lucido/ *natural ash handrail, structure and treads - polished AISI 304*
stainless steel balusters and horizontal elements



Genius r 010

corrimano e gradini frassino spazzolato tinta tortora - colonnine e struttura acciaio verniciato vinaccia (a campione) - elementi orizzontali acciaio inox/ dove grey brushed ash handrail and treads - wine red (sample colour) painted steel balusters and structure - stainless steel horizontal elements

LA CERIMONIA DEL TÈ SEDUTI SU UN GRADINO

Afternoon tea ceremony
sitting on a step



Genius r 020

corrimano e gradini frassino tinta wengé (a campione) - colonnine e struttura acciaio verniciato nero ramato/
wenge ash (sample colour) handrail and treads - coppery black painted steel balusters and structure

MAS. *il sogno in una stanza*

Mas. A dream in a room

Mas r 010 a

corrimano e gradini frassino tinta naturale - colonnine e struttura acciaio verniciato bianco RAL 9010 - elementi orizzontali acciaio inox (dettaglio pag. 131)/
natural ash handrail and treads - white RAL 9010 painted steel balusters and structure - stainless steel horizontal elements (detail page 131)



Mas r 010 b

corrimano e gradini faggio tinta naturale - colonnine e struttura acciaio verniciato grigio ghisa - elementi orizzontali PVC colore grigio ghisa (dettaglio pag. 131)/ natural beech handrail and treads - iron grey painted steel balusters and structure - iron grey coloured PVC horizontal elements (detail page 131)



light
COME IL COLORE
DELL'OTTIMISMO

As light as the colour of optimism



Oxa light r 030

corrimano, struttura e gradini faggio tinta naturale - colonnine acciaio verniciato salmone (a campione) / natural beech handrail,
structure and treads - salmon pink (sample colour) painted steel balusters



Oxa air r 090 a

struttura e gradini frassino tinta sbiancato - pannelli vetro extra chiaro/ bleached ash structure and treads - extra clear glass panels



Unika r 030

corrimano e struttura multistrato di betulla tinta naturale - colonnine acciaio verniciato bianco RAL 9010 - gradini multistrato di betulla tinta naturale laminato bianco / *natural birch plywood handrail and structure - white RAL 9010 painted steel balusters - white laminated natural birch plywood treads*

BETULLA E LAMINATO: MULTISTRATO *INVITANTE*

Birch and laminate: an inviting plywood

Unika r 030

Gradevole alla vista come una torta a più piani:

i gradini multistrato in betulla e laminato si mangiano con gli occhi, anche per l'assenza di viti a vista.

*As appealing as a multi-layered cake: you'll eat the treads in birch plywood and laminate with your eyes,
also thanks to the absence of visible screws.*

SOLIDITÀ DEL DESIGN

Solid design

Unika r 040

*L'alluminio anodizzato delle colonnine
e l'acciaio inox dei cavetti si legano al legno in perfetta sintonia.
The anodized aluminium of the balusters and the stainless steel
of the cables combine with the wood in perfect harmony.*





Clip t 030

corrimano estruso PVC verde (a campione) - colonnine, struttura e gradini acciaio verniciato verde (a campione) /
green (sample colour) extruded PVC handrail - green (sample colour) painted steel balusters, structure and treads



klio zink t 030

corrimano estruso PVC nero (dettaglio pag. 131) - colonnine, struttura e gradini acciaio zincato verniciato grigio ghisa / black extruded PVC handrail (dettaglio pag. 131) - galvanized and iron grey painted steel balusters, structure and treads



Klio zink t 030

corrimano estruso PVC nero - colonnine, struttura e gradini acciaio zincato / black extruded PVC handrail - galvanized steel balusters, structure and treads



Klio t 030

corrimano PVC nero - colonnine, struttura e gradini acciaio verniciato bianco RAL 9010/
black PVC handrail - white RAL 9010 painted steel balusters, structure and treads



Unique t 110

corrimano PVC grigio RAL 7016 - colonnine, struttura e gradini acciaio verniciato grigio RAL 7016/
grey RAL 7016 PVC handrail - grey RAL 7016 painted steel balusters, structure and treads



Af26 t 030

corrimano estruso PVC nero - colonnine, struttura e gradini acciaio verniciato nero RAL 9005/
black extruded PVC handrail - black RAL 9005 painted steel balusters, structure and treads

Minore
LO SPAZIO
MAGGIORE
L'INGEGNO

Less space, more talent



Fokus 030

colonnine e struttura acciaio verniciato bianco RAL 9010 - gradini faggio tinta noce scuro/
white RAL 9010 painted steel balusters and structure- dark walnut beech treads

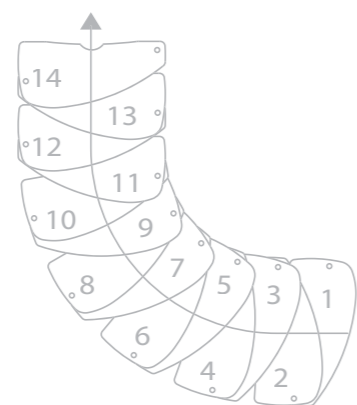

PIÙ SPAZIO AL TUO MONDO

More space for your world



Zen oio a

Le salvaspazio Fontanot sono perfette anche per configurazioni curvilinee.
La forma arrotondata dei gradini della Zen agevola la curvatura rendendo ancora più
comoda la salita e la discesa della scala.

*The Fontanot spacesavers are also ideal for curvilinear configurations.
The rounded shape of the Zen treads facilitates the curvature making it even easier
to get up and down the staircase.*



corrimano e gradini faggio noce scuro - colonnine e struttura acciaio verniciato nero RAL 9005 - elementi orizzontali acciaio inox/
dark walnut beech handrail and treads - black RAL 9005 painted steel balusters and structure - stainless steel horizontal elements

*piccolo SPAZIO
GRANDI Emozioni*

Small space, big emotions

Oxa mini 070 a

colonnine, struttura e gradini faggio tinta tortora/ dove grey beech balusters, structure and treads

SOTTOGRADO

riser



1.



2.



3.



4.



5.

1. **SG-D** SOTTOGRADO IN LEGNO per le configurazioni R, T e Q di Genius e Scenik/ WOOD RISER for Genius and Scenik R, T and Q configurations

2. **SG-E** SOTTOGRADO IN ACCIAIO per le configurazioni R delle scale in ferro e legno/ STEEL RISER BAR for R configurations of stairs in wood and steel

3. **SG-F** SOTTOGRADO IN ACCIAIO per le configurazioni T e Q delle scale in ferro e legno/ STEEL RISER BAR for T and Q configurations of stairs in wood and steel

4. **SG-G** SOTTOGRADO IN ACCIAIO per Fokus e Zen/STEEL RISER BAR for Fokus and Zen

5. **SG-H** SOTTOGRADO IN ACCIAIO per Mas/STEEL RISER BAR for Mas



6. 7.

6. **SG-A** SOTTOGRADO IN LEGNO per Diva, LaFont R e LaFont Essential/ WOOD RISER for Diva, LaFont R and LaFont Essential

7. **SG-B** SOTTOGRADO IN LEGNO per Diva, LaFont Essential, Oxa e Oxa Light/ WOOD RISER for Diva, LaFont Essential, Oxa and Oxa Light



6. **SG-A**

7. **SG-B**



8.

8. **SG-C** SOTTOGRADO IN LEGNO per Diva, LaFont R e LaFont Essential/ WOOD RISER for Diva, LaFont R and LaFont Essential

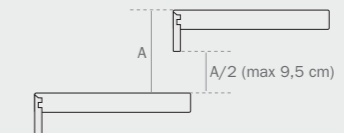

8. **SG-C**



PANNELLO DI PROTEZIONE

safety panel

Sulle scale si sale, non ci si arrampica: basta un pannello di protezione, che isola la ringhiera per impedire acrobazie e cadute, garantendo la sicurezza senza modificare lo stile della vostra scala. You walk up the stairs, you don't climb them: just install a protection panel which closes off the railing to prevent acrobatic stunts and falls, guaranteeing safety without altering the style of your staircase.

DETTAGLI

details



1.



2.



3.



4

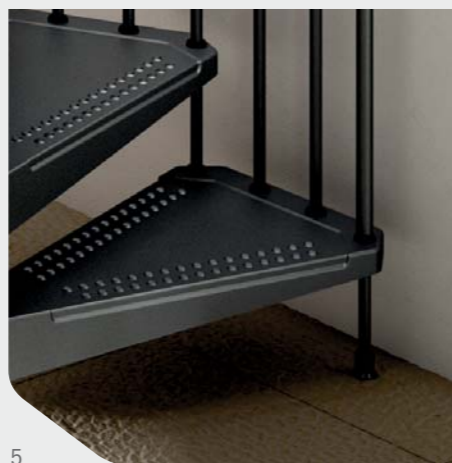

5

1 - LaFont Essential fulmine, soluzione di sottogrado SG-A/ LaFont Essential fulmine, SG-A riser solution.

2 - Mas r 010 b (pag. 99), dettaglio della struttura centrale: l'unione dei singoli supporti crea una colonna vertebrale che sostiene con leggerezza tutta la scala/ Mas

r 010 b (page 99), detail of the central structure: the connection of the single elements creates a vertebra that lightly supports the entire staircase.

3 - Mas r 010 a (pag. 97), dettaglio del corrimano della scala Mas: il frassino, nobile essenza del legno, illumina e impreziosisce



6.

l'ambiente/ Mas r 010 a (page 97), detail of the Mas stair handrail: Ash, the noble wood essence, illuminates and adorns the space.

4 - LaFont Essential fulmine r 020 a (pag. 69), dettaglio sostegno a pavimento/ LaFont Essential fulmine r 020 a (page 69), detail of the floor support.

5 - Klio Zink t 030 (pag. 113), dettaglio gradino con fori a rilievo con funzione antiscivolo e di scorrimento dell'acqua piovana/ Klio Zink t 030 (page 113), detail of the treads' raised holes with an anti-slip and rain water drainage function.

6 - Diva, particolare cosciale interno verniciato/ Diva painted internal stringer detail.



1.



2.

RINGHIERE OXA OXA RAILINGS

1 - ringhiera Oxa R 110: colonnine acciaio verniciato grigio ghisa con decori - corrimano e struttura frassino tinta noce scuro/ Oxa R 110 railing: iron grey painted steel balusters with decorations - dark walnut ash handrail and structure.

2 - ringhiera Oxa R 070 b: corrimano, colonnine e struttura frassino tinta noce biondo/ Oxa R 070 b railing: blond walnut ash handrail, balusters and structure.



ROVERE SPAZZOLATO: CORPOSO AL TATTO

Brushed oak: full-bodied to the touch

La spazzolatura del rovere esalta le venature del legno: si ha la sensazione di toccare con mano l'essenza stessa della materia. Splendido al naturale, presenta rigature ancora più accentuate nella versione sbiancata.

The brushing of the oak brings out the grain of the wood: it is as if you are touching the essence of the material itself. Wonderfully natural, its grain is even more accentuated in the bleached version.





FRASSINO SPAZZOLATO: L'ELEGANZA GLI VIENE NATURALE

Brushed ash: elegance comes naturally

Il frassino spazzolato, sottoposto a una sapiente lavorazione, caratterizza la scala conferendole un aspetto estetico di notevole pregio. La versione sbiancata si adatta bene ad ambienti moderni e minimali.

The staircase stands out for its brushed ash which, subject to expert processing, gives it a distinctive aesthetic appearance of great value. The bleached version adapts well to both modern and minimalist decor.

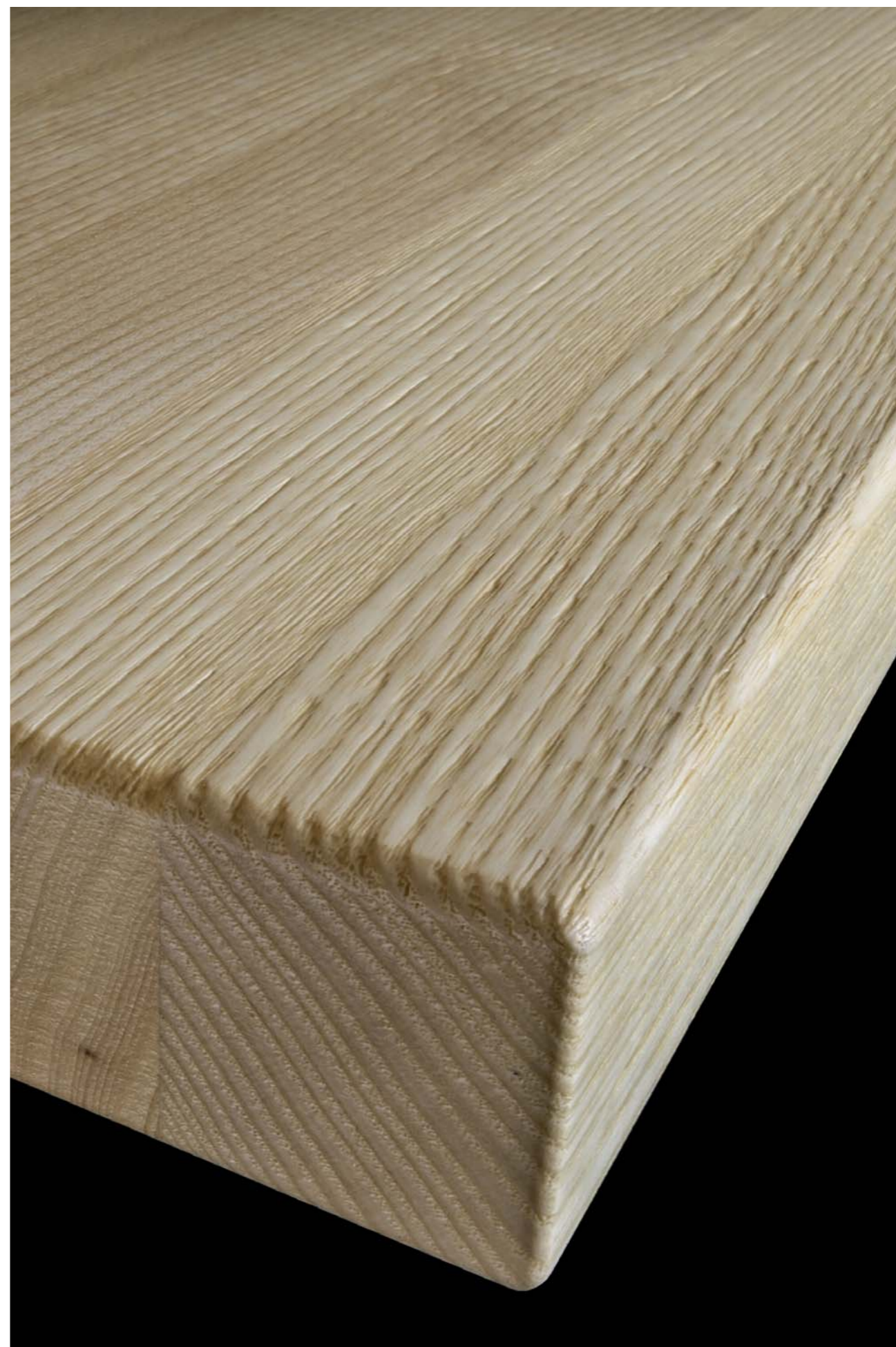

TINTE LEGNI wood shades

Per la finitura delle parti in legno Fontanot utilizza un particolare processo di verniciatura con prodotti UV all'acqua, che sono la massima espressione della tecnologia nel campo delle vernici in termini di prestazioni ed in termini di salvaguardia dell'ambiente e della salute.

To finish the wooden parts, Fontanot uses a unique painting process using water-based UV products that are at the leading edge of paint technology in terms of performance and respect for the environment and health. The result is an ecological, non-toxic material, natural to the touch and with a quality finish resistant to abrasion and the scars of time.

ROVERE/OAK

1. ROVERE TORTORA/
DOVE GREY OAK
2. ROVERE NATURALE/
NATURAL OAK
3. ROVERE SBIANCATO/
BLEACHED OAK
4. ROVERE NOCE CHIARO/
LIGHT WALNUT OAK
5. ROVERE NOCE SCURO/
DARK WALNUT OAK
6. ROVERE NOCE BIONDO/
BLOND WALNUT OAK
7. ROVERE ARDESIA
(A RICHIESTA)/
SLATE BLACK OAK
(ON DEMAND)

FRASSINO/ASH

8. FRASSINO TORTORA/
DOVE GREY ASH
9. FRASSINO NATURALE/
NATURAL ASH
10. FRASSINO SBIANCATO/
BLEACHED ASH
11. FRASSINO NOCE CHIARO/
LIGHT WALNUT ASH
12. FRASSINO NOCE SCURO/
DARK WALNUT ASH
13. FRASSINO NOCE BIONDO/
BLOND WALNUT ASH
14. FRASSINO ARDESIA
(A RICHIESTA)/
SLATE BLACK ASH
(ON DEMAND)

MULTISTRATO DI BETULLA/ BIRCH PLYWOOD

15. MULTISTRATO DI BETULLA
TORTORA/
DOVE GREY BIRCH PLYWOOD
16. MULTISTRATO DI BETULLA
NATURALE/
NATURAL BIRCH PLYWOOD
17. MULTISTRATO DI BETULLA
SBIANCATO/
BLEACHED BIRCH PLYWOOD
18. MULTISTRATO DI BETULLA
NOCE CHIARO/
LIGHT WALNUT BIRCH
PLYWOOD
19. MULTISTRATO DI BETULLA
NOCE SCURO/
DARK WALNUT
BIRCH PLYWOOD
20. MULTISTRATO DI BETULLA
NOCE BIONDO/
BLOND WALNUT BIRCH
PLYWOOD
21. MULTISTRATO DI BETULLA
ARDESIA
(A RICHIESTA)/
SLATE BLACK BIRCH
PLYWOOD
(ON DEMAND)

FAGGIO/BEECH

22. FAGGIO TORTORA/
DOVE GREY BEECH
23. FAGGIO NATURALE/
NATURAL BEECH
24. FAGGIO SBIANCATO/
BLEACHED BEECH
25. FAGGIO SBIANCATO
COPRENTE/
OPAQUE BLEACHED BEECH
26. FAGGIO NOCE CHIARO/
LIGHT WALNUT BEECH
27. FAGGIO NOCE SCURO/
DARK WALNUT BEECH
28. FAGGIO NOCE BIONDO/
BLOND WALNUT BEECH
29. FAGGIO ARDESIA
(A RICHIESTA)/
SLATE BLACK BEECH
(ON DEMAND)

BAMBOO/natural bamboo



LEGNO DI RECUPERO/recycled wood



6

PERSONALITÀ 'NATURALI' A CONFRONTO

A "Natural" personalities comparative

Il rovere,

*oltre ad essere di sangue nobile,
ha un'elevata durezza, tenacità e stabilità.*

Oak

*is not only blue blooded but has an elevated
hardness, tenacity and stability*

La betulla,

*ha il fascino della leggerezza,
ma una personalità
tutta d'un pezzo:*

si piega ma non si spezza!

Birch

*has the allure of lightness
but a solid personality:
It bends but it doesn't break!*

Il bamboo

*assorbe molta più anidride carbonica
di una foresta di legno di pari
dimensioni e rilascia il 35%
in più di ossigeno.*

Bamboo

*absorbs much more carbon dioxide
than a same size wood forest
and releases 35% more oxygen.*

Il frassino,

*è il bello "raffinato" del gruppo,
e in robustezza non è da meno
del suo amico rovere.*

Ash

*the "refined" beauty of the group,
and is no less solid
than its oak friend.*

Il faggio,

*è tra tutti, quello con la personalità
più alla mano ed elastica.*

Ama vestirsi di nuovi colori.

Beech

*among all has the most flexible
and friendly personality.
It loves to wear new colors.*

Il legno di recupero

è un legno filosofo:

*il suo pensiero ideologico è espressione di
bellezza imperfetta e per questo
dal maggior fascino.*

Reclaimed wood

*is a philosophical wood: it has an idealistic point
of view and expresses imperfect beauty which only
makes it more charming.*

TINTE LEGNI
wood shades

ROVERE/oak



1.



6.



2.



7.



3.

FRASSINO/ash



8.



4.



9.



5.



10.



11.



16.



12.



17.



13.



18.



14.



19.

MULTISTRATO
DI BETULLA/
birch plywood



15.



20.



21.

TINTE LEGNI

wood shades

FAGGIO/beech



22.



27.



23.



28.



24.

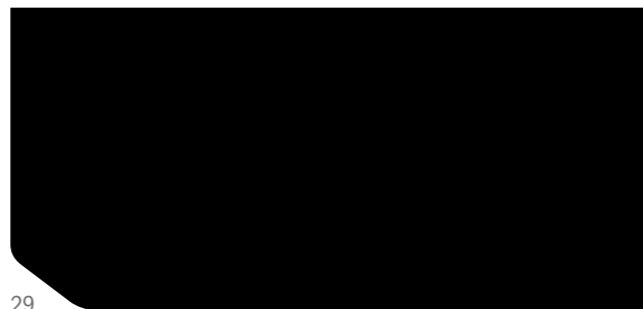

29.



25.



26.

COLORI VETRO

glass colours

1. CHIARO/CLEAR
2. EXTRA CHIARO/EXTRA CLEAR



01.



02.

COLORI ACCIAIO

steel colours

L'acciaio verniciato è disponibile in numerose finiture ed è sottoposto ad un particolare processo di verniciatura con polveri epossidiche essiccate ad alte temperature. Questo trattamento garantisce prestazioni superiori per uniformità cromatica e resistenza all'abrasione.

The painted steel is available in several different finishes and undergoes a particular epoxy powder coating process with drying at high temperatures. This treatment guarantees a superior performance in colour uniformity and resistance to abrasion.



- | | | | |
|---|---|--|---|
| 1. NERO RAL 9005 (II)/
BLACK RAL 9005 (II) | 7. BIANCO GHIACCIO RAL 9003 (III)/
COOL WHITE RAL 9003 (III) | 13. GRIGIO RAL 7039 (II)/
GREY RAL 7039 (II) | 18. ALLUMINIO ANODIZZATO/
ANODIZED ALUMINIUM |
| 2. NERO RAL 9017 (I)/
BLACK RAL 9017 (I) | 8. BIANCO PANNA RAL 9001 (III)/
OFF WHITE RAL 9001 (III) | 14. GRIGIO GHISA (III)/
IRON GREY (III) | 19. INOX AISI 304 LUCIDO/
POLISHED AISI 304
STAINLESS STEEL |
| 3. NERO RAL 9004 (III)/
BLACK RAL 9004 (III) | 9. GRIGIO (II)/
GREY (II) | 15. VERNICIATO
COLORE CORTEN (II)/
CORTEN-COLOURED
PAINTED STEEL (II) | 20. INOX AISI 304 SATINATO/
SATIN AISI 304 STAINLESS STEEL |
| 4. NERO RAMATO (III)/
COPPERY BLACK (III) | 10. GRIGIO RAL 9006 (II)/
GREY RAL 9006 (II) | 16. NICHEL SATINATO (III)/
SATIN NICKEL-PLATED (III) | 21. ZINCATO/
GALVANIZED |
| 5. BIANCO RAL 9010 (II)/
WHITE RAL 9010 (II) | 11. GRIGIO RAL 7016 (III)/
GREY RAL 7016 (III) | 17. CROMO (I)/
CHROME (I) | |
| 6. BIANCO (III)/
WHITE (III) | 12. GRIGIO RAL 7030 (I)/
GREY RAL 7030 (I) | | |

I - liscio-lucido/smooth-polished II - goffrato-opaco/embossed-matt III - liscio-opaco/smooth-matt

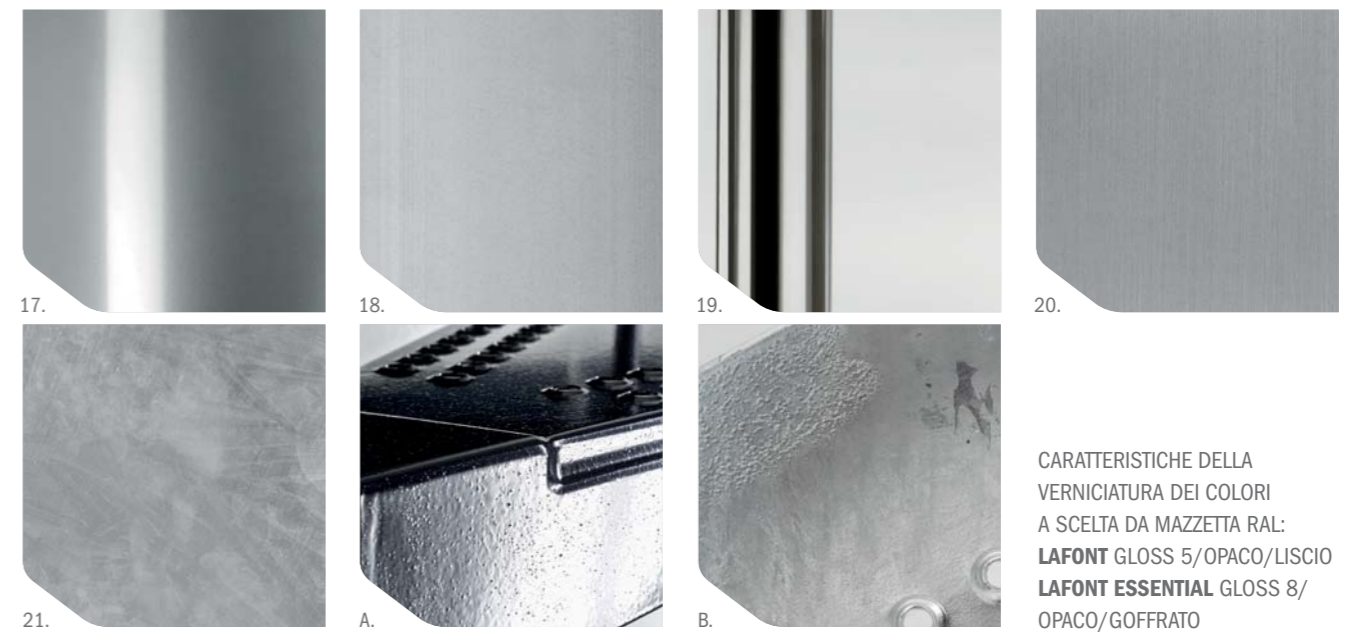

A. KLIO ZINK
L'irregolarità della superficie di Klio Zink zincata e verniciata è una caratteristica del duplice trattamento antiruggine e antiusura/The irregularities of the galvanized and painted steel Klio Zink surface are a feature of the dual anti-rust and anti-wear treatment.

B. KLIO ZINK
L'irregolarità e i segni scuri della superficie sono caratteristici del processo industriale di protezione contro la corrosione dell'acciaio/The irregularities and the dark spots on the surface are a normal characteristic of the galvanization process. The treads are hot dipped in a zinc solution at 400° C: the best industrial process to protect steel from any form of corrosion.

CARATTERISTICHE DELLA VERNICIATURA DEI COLORI A SCELTA DA MAZZETTA RAL:
LAFONT GLOSS 5/OPACO/LISCIO
LAFONT ESSENTIAL GLOSS 8/OPACO/GOFFRATO

CHARACTERISTICS OF THE PAINT COLOURS CHOSEN FROM THE RAL SWATCH:
LAFONT GLOSS 5/MATT/SMOOTH
LAFONT ESSENTIAL GLOSS 8/MATT/EMBOSSED



ACCANTO A VOI GRADINO DOPO GRADINO

VISIONE DIRETTA DEI PRODOTTI

per toccare con mano la qualità di materiali e finiture,
grazie ad una rete di show room capillare su tutto il territorio;

MISURAZIONE E PREVENTIVO GRATUITI

avrete a disposizione un tecnico, che verrà a casa vostra per
effettuare le misurazioni necessarie e fornirvi un preventivo
personalizzato per il vostro progetto;

CERTEZZA DEI TEMPI DI CONSEGNA

siamo rapidi e puntuali per principio,
il design della vostra casa non può aspettare!

POSA E INSTALLAZIONE

un operatore qualificato della nostra rete di posatori vi aiuterà
a installare la vostra scala in maniera impeccabile;

GARANZIA

ogni nostra scala è coperta da garanzia.

PULIZIA E MANUTENZIONE: IN OGNI SCHEDA PRODOTTO

oltre alle caratteristiche tecnico-costruttive, vi forniamo utili consigli
e informazioni sulle modalità di pulizia e manutenzione,
per una scala ancora più bella ancora più a lungo;

SERVIZIO POST VENDITA PUNTUALE

l'Ufficio Commerciale Fontanot è pronto a rispondere
a qualsiasi vostra domanda e a trovare la soluzione
per ogni esigenza;

NUMERO VERDE 800.847.021

è il numero della nostra assistenza gratuita,
per avere informazioni sul punto vendita della vostra città.
Chiamateci!



BY YOUR SIDE STEP BY STEP

DIRECT VIEWING OF PRODUCTS

the extensive showroom structure enables you to get hands-on
experience of products;

FREE MEASUREMENTS AND QUOTES

a technical expert will come to your home to take the necessary
measurements and to provide you with a customised quote for your
project;

GUARANTEED DELIVERY TIMES

speed and punctuality are two of our key values; the design of your
home cannot wait!

INSTALLATION

a qualified professional from our network of installers will help you
install your staircase to perfection;

WARRANTY

all our staircases are covered by a warranty.

CLEANING AND MAINTENANCE

every product data sheet contains information on technical/
construction features as well as useful tips and information on
cleaning and maintenance, for a staircase that is even more stunning
for longer;

PROMPT AFTER-SALES SERVICE

the Fontanot Sales Department will gladly help you with any questions
you may have and find the right solution for all your requirements.

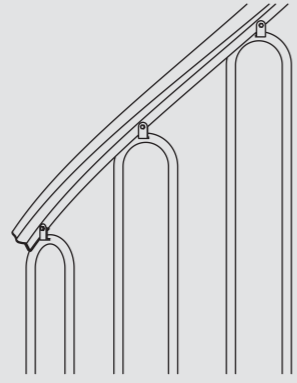
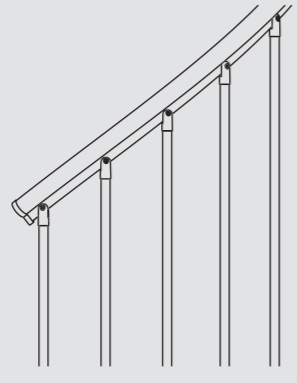
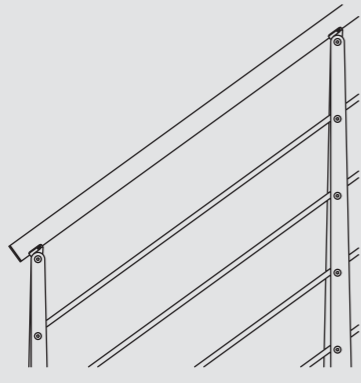

tabella
riassuntiva
summary
table

Scala/Staircase	Ringhiera/Railing	Materiali e colori	Materials and colours
AF 26 T (p. 121)	030 	<p>corrimano PVC estruso sagomato: nero</p> <p>colonnine D20 + struttura acciaio: bianco RAL 9010 (I) grigio RAL 9006 (II) nero RAL 9005 (II)</p>	<p>extruded PVC moulded handrail: black</p> <p>steel D20 balusters + structure: white RAL 9010 (I) grey RAL 9006 (II) black RAL 9005 (II)</p>
Clip T (p. 111)	030 	<p>corrimano estruso PVC ellittico + fissaggi plastica: bianco RAL 9010 nero RAL 9005</p> <p>colonnine D20 + struttura acciaio: bianco RAL 9010 (I) nero RAL 9005 (II)</p>	<p>extruded PVC oval handrail + plastic fixings: white RAL 9010 black RAL 9005</p> <p>steel D20 balusters + structure: white RAL 9010 (I) black RAL 9005 (II)</p>
Diva	060 B 	<p>corrimano: inox AISI 304 lucido inox AISI 304 satinato legno (opzionale)</p> <p>colonnine doppio piatto acciaio: bianco RAL 9010 (I) bianco RAL 9010 (III) grigio ghisa (I) grigio ghisa (III) nero RAL 9004 (I) nero RAL 9004 (III)</p> <p>struttura acciaio: inox AISI 304 lucido inox AISI 304 satinato bianco RAL 9010 (I) bianco RAL 9010 (III) grigio ghisa (I) grigio ghisa (III) nero RAL 9004 (I) nero RAL 9004 (III)</p> <p>elementi orizzontali tubini acciaio inox AISI 304: satinato lucido</p>	<p>handrail: polished AISI 304 stainless steel satin AISI 304 stainless steel wood (optional)</p> <p>steel double plate balusters: white RAL 9010 (I) white RAL 9010 (III) iron grey (I) iron grey (III) black RAL 9004 (I) black RAL 9004 (III)</p> <p>steel structure: polished AISI 304 stainless steel satin AISI 304 stainless steel white RAL 9010 (I) white RAL 9010 (III) iron grey (I) iron grey (III) black RAL 9004 (I) black RAL 9004 (III)</p> <p>horizontal elements AISI 304 stainless steel tubes: satin polished</p>

Colori opzionali acciaio	Optional steel colours	■	Materiale gradini	Tread material	Tinte legno	Wood shades	▲
—	—	—	acciaio	steel	—	—	—
—	—	—	acciaio	steel	—	—	—
—	—	si/yes	frassino (IV) rovere (IV)	ash (IV) oak (IV)	naturale	natural	si/yes
—	—	si/yes	vetro con bordi a filo lucido piatto rilavorati dopo l'accoppiamento: extra chiaro	glass with a flat and polished edge reworked after couplin: extra-clear	—	—	—
—	—	si/yes	multistrato di betulla	birch plywood	laccato bianco	lacquered white	si/yes

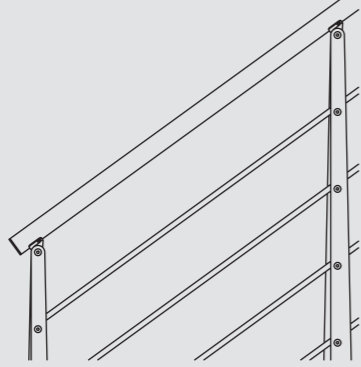
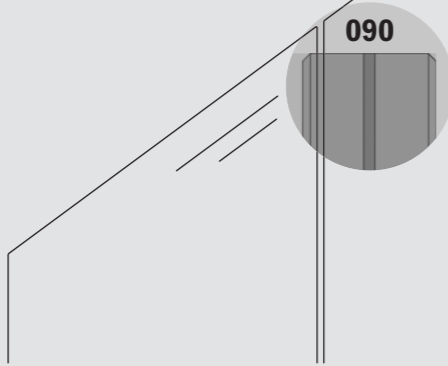
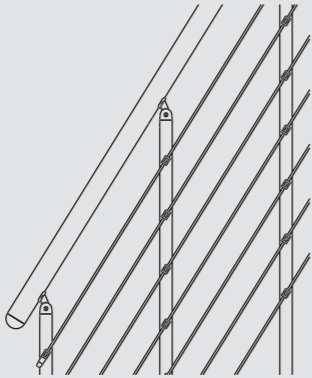
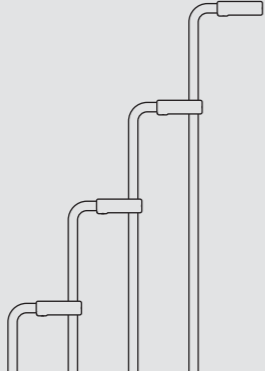
Scala/Staircase	Ringhiera/Railing	Materiali e colori	Materials and colours
Diva (p. 17)	060 BX 	<p>corrimano: inox AISI 304 lucido inox AISI 304 satinato legno (opzionale)</p> <p>colonnine doppio piatto: lucido satinato</p> <p>struttura acciaio: inox AISI 304 lucido inox AISI 304 satinato bianco RAL 9010 (I) grigio ghisa (I) grigio ghisa (III) nero RAL 9004 (I) nero RAL 9004 (III)</p> <p>elementi orizzontali tubini acciaio inox AISI 304: satinato lucido</p>	<p>handrail: satin polished wood (optional)</p> <p>AISI 304 stainless steel double plate balusters: polished satin</p> <p>steel structure: polished AISI 304 stainless steel satin AISI 304 stainless steel white RAL 9010 (I) white RAL 9010 (III) iron grey (I) iron grey (III) black RAL 9004 (I) black RAL 9004 (III)</p> <p>horizontal elements AISI 304 stainless steel tubes: satin polished</p>
Diva (p. 19)	090 	<p>pannelli vetro: con bordi a filo lucido piatto rilavorati dopo l'accoppiamento vetro extra chiaro</p> <p>struttura acciaio: inox AISI 304 lucido inox AISI 304 satinato bianco RAL 9010 (I) grigio ghisa (I) grigio ghisa (III) nero RAL 9004 (I) nero RAL 9004 (III)</p>	<p>glass panels: with a flat and polished edge reworked after couplin extra-clear glass</p> <p>steel structure: polished AISI 304 stainless steel satin AISI 304 stainless steel white RAL 9010 (I) white RAL 9010 (III) iron grey (I) iron grey (III) black RAL 9004 (I) black RAL 9004 (III)</p>
Fokus	010 	<p>corrimano PVC effetto legno con anima alluminio: nelle tinte dei gradini</p> <p>colonnine D27 + struttura acciaio: bianco RAL 9010 (I) grigio RAL 9006 (II) nero RAL 9017 (I)</p> <p>fissaggi plastica: grigio RAL 9006 (II) nero RAL 9017 (I) (sull'acciaio bianco i fissaggi sono sempre grigi)</p> <p>elementi orizzontali: cavi acciaio inox</p>	<p>wood effect PVC handrail with aluminium core: in matching shades with the treads</p> <p>steel D27 balusters + structure: white RAL 9010 (I) grey RAL 9006 (II) black RAL 9017 (I)</p> <p>plastic fixings: grey RAL 9006 (II) black RAL 9017 (I) (with white steel, the fixings are grey)</p> <p>horizontal elements: stainless steel cables</p>
Fokus (p. 123)	030 	<p>colonnine D20 + struttura acciaio: bianco RAL 9010 (I) grigio RAL 9006 (II) nero RAL 9017 (I)</p> <p>fissaggi plastica: nero</p>	<p>steel D20 balusters + structure: white RAL 9010 (I) grey RAL 9006 (II) black RAL 9017 (I)</p> <p>plastic fixings: black</p>

Colori opzionali acciaio	Optional steel colours	■	Materiali gradini	Tread material	Tinte legno	Wood shades	▲
—	—	si/yes	frassino (IV) rovere (IV)	ash (IV) oak (IV)	naturale	natural	si/yes
—	—	si/yes	vetro con bordi a filo lucido piatto rilavorati dopo l'accoppiamento: extra chiaro	glass with a flat and polished edge reworked after couplin: extra-clear	—	—	—
—	—	si/yes	multistrato di betulla	birch plywood	laccato bianco	lacquered white	si/yes
—	—	si/yes	frassino (IV) rovere (IV)	ash (IV) oak (IV)	naturale	natural	si/yes
—	—	si/yes	vetro con bordi a filo lucido piatto rilavorati dopo l'accoppiamento: extra chiaro	glass with a flat and polished edge reworked after couplin: extra-clear	—	—	—
—	—	si/yes	multistrato di betulla	birch plywood	laccato bianco	lacquered white	si/yes
—	—	—	faggio	beech	naturale noce scuro	natural dark walnut	—
—	—	—	faggio	beech	naturale noce scuro	natural dark walnut	—

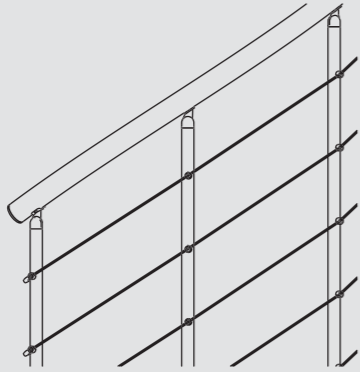
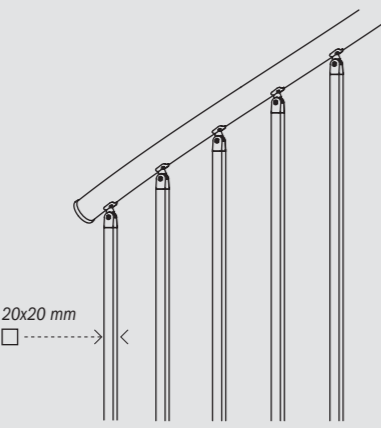
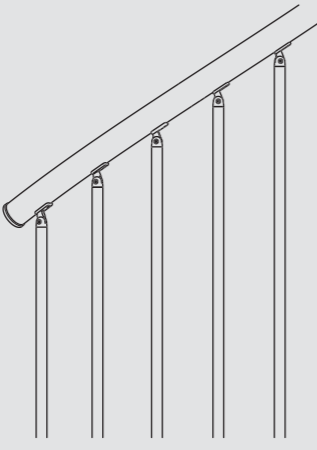
Scala/Staircase	Ringhiera/Railing	Materiali e colori	Materials and colours
Genius T Genius Q Genius 2:Easy Genius R (p. 93)	010 	corrimano legno: nelle essenze e tinte dei gradini colonnine D27 + struttura + fissaggi acciaio: bianco RAL 9010 (II) cromo (I) grigio ghisa (III) grigio RAL 9006 (II) nero ramato (III) Genius T, Q, 2:Easy: disponibilità struttura in legno nelle essenze e tinte dei gradini elementi orizzontali: cavi acciaio inox	wood handrail: in matching materials and shades with the treads steel D27 balusters + structure + fixings: white RAL 9010 (II) chrome (I) iron grey (III) grey RAL 9006 (II) coppery black (III) Genius T, Q, 2:Easy: wood structure available in matching materials and shades with the treads horizontal elements stainless steel cables
Genius T (p. 89) Genius Q Genius 2:Easy Genius R (p. 95)	020 	corrimano legno: nelle essenze e tinte dei gradini colonnine quadrate + struttura acciaio: bianco RAL 9010 (II) cromo (I) grigio ghisa (III) grigio RAL 9006 (II) nero ramato (III) fissaggi plastica: bianco RAL 9010 cromo grigio ghisa grigio RAL 9006 nero ramato Genius T, Q, 2:Easy: disponibilità struttura in legno nelle essenze e tinte dei gradini	wood handrail: in matching materials and shades with the treads steel square section balusters + structure: white RAL 9010 (II) chrome (I) iron grey (III) grey RAL 9006 (II) coppery black (III) plastic fixings: white RAL 9010 chrome iron grey grey RAL 9006 coppery black Genius T, Q, 2:Easy: wood structure available in matching materials and shades with the treads
Genius T Genius Q Genius 2:Easy (p. 79) Genius R	030 	corrimano legno: nelle essenze e tinte dei gradini colonnine D20 + struttura acciaio: bianco RAL 9010 (II) cromo (I) grigio ghisa (III) grigio RAL 9006 (II) nero ramato (III) fissaggi plastica: bianco RAL 9010 cromo grigio ghisa grigio RAL 9006 nero ramato Genius T, Q, 2:Easy: disponibilità struttura in legno nelle essenze e tinte dei gradini	wood handrail: in matching materials and shades with the treads steel D20 balusters + structure: white RAL 9010 (II) chrome (I) iron grey (III) grey RAL 9006 (II) coppery black (III) plastic fixings: white RAL 9010 chrome iron grey grey RAL 9006 coppery black Genius T, Q, 2:Easy: wood structure available in matching materials and shades with the treads

Colori opzionali acciaio	Optional steel colours	■ Materiale gradini	Tread material	Tinte legno	Wood shades	▲	
—	—	—	faggio frassino (IV) rovere (IV)	beech ash (IV) oak (IV)	naturale noce biondo noce chiaro noce scuro sbiancato tortora	natural blond walnut light walnut dark walnut bleached dove grey	si/yes
—	—	—	faggio frassino (IV) rovere (IV)	beech ash (IV) oak (IV)	naturale noce biondo noce chiaro noce scuro sbiancato tortora	natural blond walnut light walnut dark walnut bleached dove grey	si/yes
—	—	—	faggio frassino (IV) rovere (IV)	beech ash (IV) oak (IV)	naturale noce biondo noce chiaro noce scuro sbiancato tortora	natural blond walnut light walnut dark walnut bleached dove grey	si/yes

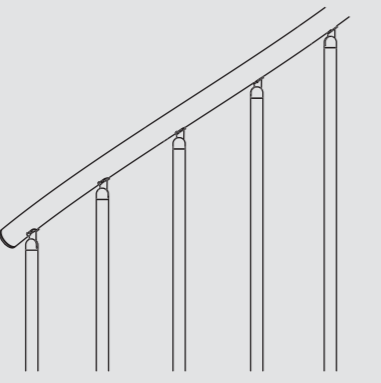
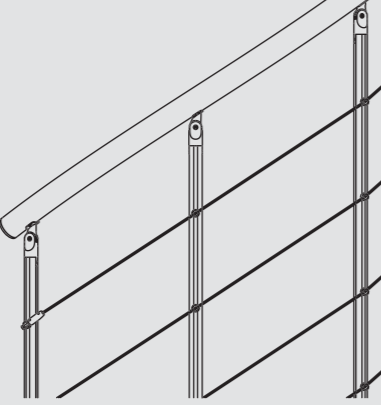
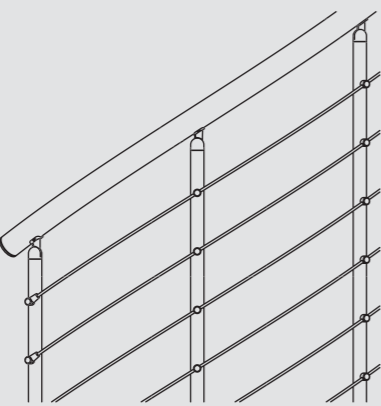
Scala/Staircase	Ringhiera/Railing	Materiali e colori	Materiali e colori
Genius T (p. 87) Genius Q Genius 2:Easy Genius R	030 A 	corrimano legno: nelle essenze e tinte dei gradini	wood handrail: <i>in matching materials and shades with the treads</i>
		colonnine D27 + struttura + fissaggi acciaio: bianco RAL 9010 (II) cromo (I) grigio ghisa (III) grigio RAL 9006 (II) nero ramato (III)	steel D27 balusters + structure + fixings: white RAL 9010 (II) chrome (I) iron grey (III) grey RAL 9006 (II) coppery black (III)
		Genius T, Q, 2:Easy: disponibilità struttura in legno nelle essenze e tinte dei gradini	Genius T, Q, 2:Easy: <i>wood structure available in matching materials and shades with the treads</i>
Genius T Genius Q Genius 2:Easy Genius R	040 	corrimano legno: nelle essenze e tinte dei gradini	wood handrail: <i>in matching materials and shades with the treads</i>
		colonnine D27 + fissaggi alluminio: anodizzato	aluminium D27 balusters + fixings: anodized
		struttura acciaio: bianco RAL 9010 (II) cromo (I) grigio ghisa (III) grigio RAL 9006 (II) nero ramato (III)	steel structure: white RAL 9010 (II) chrome (I) iron grey (III) grey RAL 9006 (II) coppery black (III)
Genius T, Q, 2:Easy: disponibilità struttura in legno nelle essenze e tinte dei gradini	Genius T, Q, 2:Easy: <i>wood structure available in matching materials and shades with the treads</i>	elementi orizzontali: cavi acciaio inox	horizontal elements: stainless steel cables
Genius T (p. 85) Genius Q (p. 91) Genius 2:Easy Genius R	050 	corrimano legno: nelle essenze e tinte dei gradini	wood handrail: <i>in matching materials and shades with the treads</i>
		colonnine D27 acciaio inox AISI 304: lucido	AISI 304 stainless steel D27 balusters: polished
		struttura acciaio: bianco RAL 9010 (II) cromo (I) grigio ghisa (III) grigio RAL 9006 (II) nero ramato (III) nichel satinato (III) acciaio inox AISI 304 lucido (solo Genius T/Q/2:Easy)	steel structure: white RAL 9010 (II) chrome (I) iron grey (III) grey RAL 9006 (II) coppery black (III) satin nickel-plated (III) polished AISI 304 stainless steel (only Genius T/Q/2:Easy)
Genius T, Q, 2:Easy: disponibilità struttura in legno nelle essenze e tinte dei gradini	Genius T, Q, 2:Easy: <i>wood structure available in matching materials and shades with the treads</i>	fissaggi acciaio: nichel satinato	steel fixings: satin nickel plated
elementi orizzontali: tondini acciaio inox	horizontal elements: stainless steel bars		

Colori opzionali acciaio	Optional steel colours	■	Materiali gradini	Tread material	Tinte legno	Wood shades	▲
—	—	—	faggio frassino (IV) rovere (IV)	beech ash (IV) oak (IV)	naturale noce biondo noce chiaro noce scuro sbiancato tortora	natural blond walnut light walnut dark walnut bleached dove grey	si/yes
—	—	—	faggio frassino (IV) rovere (IV)	beech ash (IV) oak (IV)	naturale noce biondo noce chiaro noce scuro sbiancato tortora	natural blond walnut light walnut dark walnut bleached dove grey	si/yes
—	—	—	faggio frassino (IV) rovere (IV)	beech ash (IV) oak (IV)	naturale noce biondo noce chiaro noce scuro sbiancato tortora	natural blond walnut light walnut dark walnut bleached dove grey	si/yes

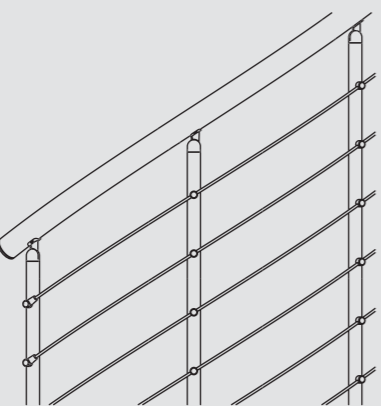
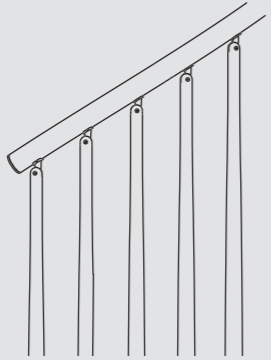
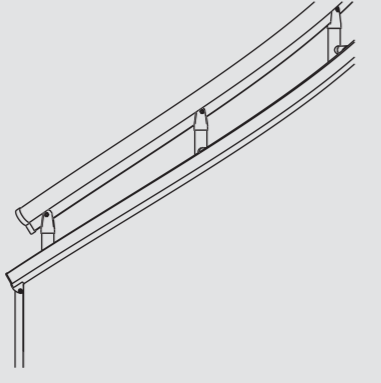
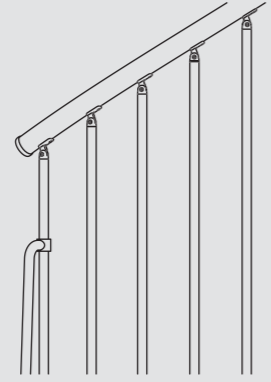
Scala/Staircase	Ringhiera/Railing	Materiali e colori	Materials and colours
Genius T (p. 83) Genius Q Genius 2:Easy Genius R	050 A 	<p>corrimano legno: nelle essenze e tinte dei gradini</p> <p>colonnine D27 + fissaggi acciaio: nichel satinato (III)</p> <p>struttura acciaio: bianco RAL 9010 (II) cromo (I) grigio ghisa (III) grigio RAL 9006 (II) nero ramato (III) nichel satinato (III)</p> <p>Genius T, Q, 2:Easy: disponibilità struttura in legno nelle essenze e tinte dei gradini</p> <p>elementi orizzontali: tondini acciaio inox</p>	<p>wood handrail: in matching materials and shades with the treads</p> <p>steel D27 balusters + fixings: satin nickel-plated (III)</p> <p>steel structure: white RAL 9010 (II) chrome (I) iron grey (III) grey RAL 9006 (II) coppery black (III) satin nickel-plated (III)</p> <p>Genius T, Q, 2:Easy: wood structure available in matching materials and shades with the treads</p> <p>horizontal elements: stainless steel bars</p>
Genius T (p. 77) Genius Q Genius 2:Easy Genius R	070 	<p>corrimano + colonnine legno: nelle essenze e tinte dei gradini</p> <p>struttura + fissaggi acciaio: bianco RAL 9010 (II) cromo (I) grigio ghisa (III) grigio RAL 9006 (II) nero ramato (III)</p> <p>Genius T, Q, 2:Easy: disponibilità struttura in legno nelle essenze e tinte dei gradini</p>	<p>wood handrail + balusters: in matching materials and shades with the treads</p> <p>steel structure + fixings: white RAL 9010 (II) chrome (I) iron grey (III) grey RAL 9006 (II) coppery black (III)</p> <p>Genius T, Q, 2:Easy: wood structure available in matching materials and shades with the treads</p>
Genius T (p. 75)	100 Skin 	<p>corrimano PVC estruso: bianco RAL 9010 (per tessuto plastico bianco) grigio RAL 7030 (per tessuto plastico Skin Square)</p> <p>colonnine D27 + struttura + fissaggi acciaio: bianco RAL 9010 (II) grigio RAL 7030 (I)</p> <p>tessuto plastico: bianco (per bianco RAL 9010) Skin Square (per grigio RAL 7030)</p>	<p>extruded PVC handrail: white RAL 9010 (with white plastic fabric) grey RAL 7030 (with Skin Square plastic fabric)</p> <p>steel D27 balusters + structure + fixings: white RAL 9010 (II) grey RAL 7030 (I)</p> <p>plastic fabric: white (with white RAL 9010) Skin Square (with grey RAL 7030)</p>
Klio T (p. 117)	030 	<p>corrimano PVC con anima alluminio: nero</p> <p>colonnine D20 + struttura acciaio: bianco RAL 9010 (I) grigio RAL 9006 (II) nero RAL 9017 (I)</p> <p>fissaggi plastica: bianco RAL 9010 grigio RAL 9006 nero RAL 9017</p>	<p>PVC handrail with aluminium core: black</p> <p>steel D20 balusters + structure: white RAL 9010 (I) grey RAL 9006 (II) black RAL 9017 (I)</p> <p>plastic fixings: white RAL 9010 grey RAL 9006 black RAL 9017</p>

Colori opzionali acciaio	Optional steel colours	■	Materiali gradini	Tread material	Tinte legno	Wood shades	▲
—	—	—	faggio frassino (IV) rovere (IV)	beech ash (IV) oak (IV)	naturale noce biondo noce chiaro noce scuro sbiancato tortora	natural blond walnut light walnut dark walnut bleached dove grey	si/yes
—	—	—	faggio frassino (IV) rovere (IV)	beech ash oak	naturale noce biondo noce chiaro noce scuro sbiancato tortora	natural blond walnut light walnut dark walnut bleached dove grey	si/yes
—	—	—	faggio frassino (IV) rovere (IV)	beech ash (IV) oak (IV)	naturale noce biondo noce chiaro noce scuro sbiancato tortora	natural blond walnut light walnut dark walnut bleached dove grey	si/yes
—	—	—	acciaio	steel	—	—	—

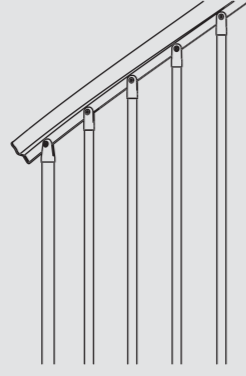
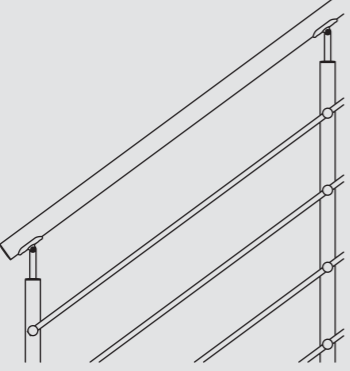
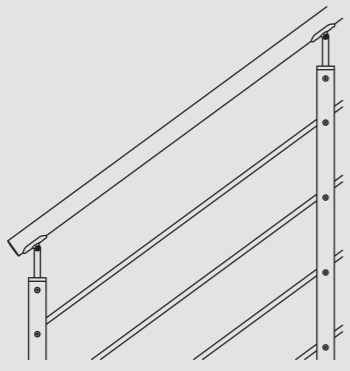
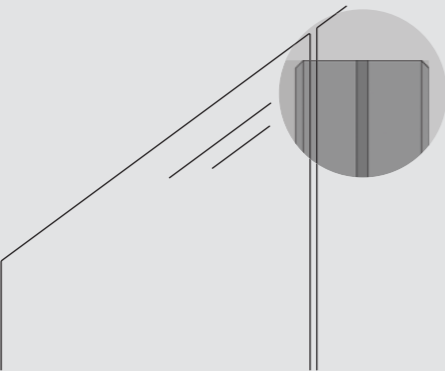
Scala/Staircase	Ringhiera/Railing	Materiali e colori	Materials and colours
Klio Zink T <i>zincata/galvanized steel (p. 115)</i> Klio Zink T <i>zincata verniciata/painted galvanized steel (p. 113)</i>	030 	corrimano PVC estruso + fissaggi: nero colonnine D20 + struttura acciaio: zincato colonnine D20 + struttura acciaio zincato e verniciato: bianco RAL 9010 (I) grigio ghisa (III) grigio RAL 9006 (II) nero RAL 9017 (I)	extruded PVC handrail + fixings: black steel D20 balusters + structure: galvanized galvanized and painted steel D20 balusters + structure: white RAL 9010 (I) iron grey (III) grey RAL 9006 (II) black RAL 9017 (I)
LaFont Fulmine R LaFont Fascia R LaFont Lastra T (p. 27) LaFont Spira T	050 B 	corrimano + colonnine D34 + fissaggi acciaio inox AISI 304: satinato struttura acciaio: bianco (III) inox AISI 304 lucido inox AISI 304 satinato nero RAL 9004 (III) elementi orizzontali: tubini acciaio inox AISI 304 satinato	AISI 304 stainless steel handrail + D34 balusters + fixings: satin steel structure: white (III) polished AISI 304 stainless steel satin AISI 304 stainless steel black RAL 9004 (III) horizontal elements: AISI 304 satin stainless steel tubes
LaFont Fulmine R LaFont Fascia R LaFont Lastra T LaFont Spira T (p. 29)	060 C 	corrimano + colonnine doppio piatto + fissaggi acciaio inox AISI 304: satinato lucido struttura acciaio: bianco (III) inox AISI 304 lucido inox AISI 304 satinato nero RAL 9004 (III) elementi orizzontali: tubini acciaio inox AISI 304 satinato	AISI 304 stainless steel handrail + double plate balusters + fixings: satin polished steel structure: white (III) polished AISI 304 stainless steel satin AISI 304 stainless steel black RAL 9004 (III) horizontal elements: AISI 304 satin stainless steel tubes
LaFont Fulmine R LaFont Fascia R (p. 41)	090 	pannelli vetro: con bordi a filo lucido piatto rilavorati dopo l'accoppiamento vetro chiaro vetro extra chiaro struttura acciaio: bianco (III) inox AISI 304 lucido inox AISI 304 satinato nero RAL 9004 (III) fissaggi acciaio inox AISI 304: rotules con finitura satinata	glass panels: with a flat and polished edge reworked after couplin clear glass extra-clear glass steel structure: white (III) polished AISI 304 stainless steel satin AISI 304 stainless steel black RAL 9004 (III) AISI 304 stainless steel fixings: satin rotules

I - liscio-lucido/smooth-polished II - gofrato-opaco/embossed-matt III - liscio-opaco/smooth-matt IV - a richiesta spazzolato/brushed upon request

Colori opzionali acciaio	Optional steel colours	■	Materiali gradini	Tread material	Tinte legno	Wood shades	▲
—	—	—	acciaio	steel	—	—	—
—	—	sì/yes*	bamboo (naturale) multistrato di betulla laccato faggio frassino (IV) rovere (IV) vetro chiaro vetro extra chiaro	bamboo (natural) lacquered birch plywood beech ash (IV) oak (IV) clear glass extra clear glass	naturale noce biondo noce chiaro noce scuro sbiancato tortora	natural blond walnut light walnut dark walnut bleached dove grey	sì/yes
—	—	sì/yes*	bamboo (naturale) multistrato di betulla laccato faggio frassino (IV) rovere (IV) vetro chiaro vetro extra chiaro	bamboo (natural) lacquered birch plywood beech ash (IV) oak (IV) clear glass extra clear glass	naturale noce biondo noce chiaro noce scuro sbiancato tortora	natural blond walnut light walnut dark walnut bleached dove grey	sì/yes
—	—	sì/yes*	bamboo (naturale) multistrato di betulla laccato faggio frassino (IV) rovere (IV) vetro chiaro vetro extra chiaro	bamboo (natural) lacquered birch plywood beech ash (IV) oak (IV) clear glass extra clear glass	naturale noce biondo noce chiaro noce scuro sbiancato tortora	natural blond walnut light walnut dark walnut bleached dove grey	sì/yes

■ colore acciaio a scelta da mazzetta RAL/steel colour chosen on RAL swatch ▲ colore legno a campione/personalized wood shade * solo struttura/structure only

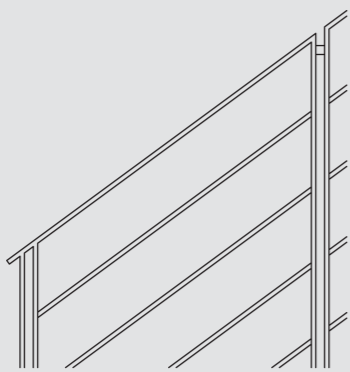
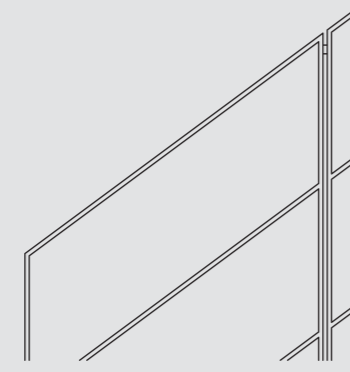
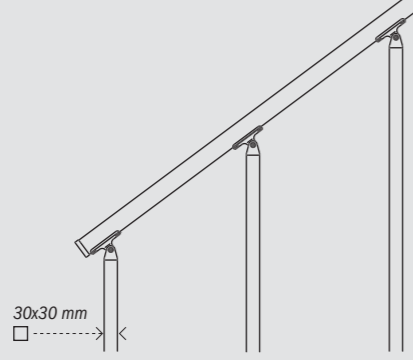
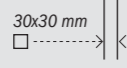
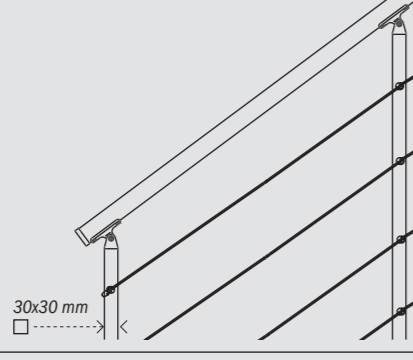
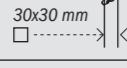
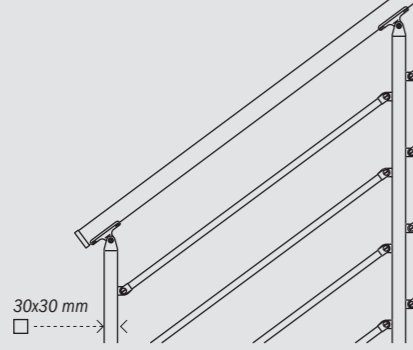
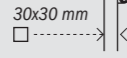
Scala/Staircase	Ringhiera/Railing	Materiali e colori	Materials and colours
LaFont Fulmine R (p. 47) LaFont Fascia R	120 B 	corrimano + colonnine (piatti 40x10) + struttura acciaio: bianco (III) nero RAL 9004 (III)	steel handrail + balusters (40x10 plates) + structure: white (III) black RAL 9004 (III)
		elementi orizzontali tondini saldati acciaio: bianco (III) nero RAL 9004 (III)	horizontal elements steel welded bars white (III) black RAL 9004 (III)
LaFont Fulmine R (p. 51) LaFont Fascia R	120 C 	corrimano + colonnine (piatti 40x10) acciaio inox AISI 304: satinato	AISI 304 stainless steel handrail + balusters (40x10 plates): satin
		struttura acciaio: bianco (III) inox AISI 304 lucido inox AISI 304 satinato nero RAL 9004 (III)	steel structure: white (III) polished AISI 304 stainless steel satin AISI 304 stainless steel black RAL 9004 (III)
		elementi orizzontali (piatti 40x10) acciaio inox AISI 304: satinato	AISI 304 stainless steel horizontal elements (40x10 plates): satin
LaFont Essential Fulmine R LaFont Essential Fascia R	020 	corrimano + colonnine quadrate + struttura acciaio: bianco RAL 9010 (II) nero RAL 9005 (II) grigio RAL 9006 (II)	steel handrail + square section balusters + structure: white RAL 9010 (II) black RAL 9005 (II) grey RAL 9006 (II)
		fissaggi zama: bianco RAL 9010 (II) nero RAL 9005 (II) grigio RAL 9006 (II)	zama fixings: white RAL 9010 (II) black RAL 9005 (II) grey RAL 9006 (II)
		30x30 mm 	
LaFont Essential Fulmine R (p. 69) LaFont Essential Fascia R	020 A 	corrimano + colonnine quadrate + struttura acciaio: bianco RAL 9010 (II) nero RAL 9005 (II) grigio RAL 9006 (II)	steel handrail + square section balusters + structure: white RAL 9010 (II) black RAL 9005 (II) grey RAL 9006 (II)
		fissaggi zama: bianco RAL 9010 (II) nero RAL 9005 (II) grigio RAL 9006 (II)	zama fixings: white RAL 9010 (II) black RAL 9005 (II) grey RAL 9006 (II)
		30x30 mm 	
LaFont Essential Fulmine R (p. 67) LaFont Essential Fascia R	020 B 	corrimano + colonnine quadrate + struttura acciaio + fissaggi zama: bianco RAL 9010 (II) nero RAL 9005 (II) grigio RAL 9006 (II)	steel handrail + square section balusters + structure + zama fixings: white RAL 9010 (II) black RAL 9005 (II) grey RAL 9006 (II)
		elementi orizzontali tubi quadrati (15x15 mm) acciaio: bianco RAL 9010 (II) nero RAL 9005 (II) grigio RAL 9006 (II)	horizontal elements steel square section (15x15 mm) tubes: white RAL 9010 (II) black RAL 9005 (II) grey RAL 9006 (II)
		30x30 mm 	

I - liscio-lucido/smooth-polished II - gofrato-opaco/embossed-matt III - liscio-opaco/smooth-matt IV - a richiesta spazzolato/brushed upon request

Colori opzionali acciaio	Optional steel colours	■	Materiali gradini	Tread material	Tinte legno	Wood shades	▲
—	—	si/yes	bamboo (naturale) multistrato di betulla laccato faggio frassino (IV) rovere (IV)	bamboo (natural) lacquered birch plywood beech ash (IV) oak (IV)	naturale noce biondo noce chiaro noce scuro sbiancato tortora	natural blond walnut light walnut dark walnut bleached dove grey	si/yes
—	—	si/yes*	bamboo (naturale) multistrato di betulla laccato faggio frassino (IV) rovere (IV)	bamboo (natural) lacquered birch plywood beech ash (IV) oak (IV)	naturale noce biondo noce chiaro noce scuro sbiancato tortora	natural blond walnut light walnut dark walnut bleached dove grey	si/yes
—	—	—	faggio frassino (IV) rovere (IV) multistrato di betulla	beech ash (IV) oak (IV) birch plywood	naturale noce biondo noce chiaro noce scuro sbiancato tortora grezzo	natural blond walnut light walnut dark walnut bleached dove grey unpolished	si/yes
—	—	—	multistrato di betulla laccato (opzionale) acciaio	lacquered birch plywood (optional) steel			
—	—	—	faggio frassino (IV) rovere (IV) multistrato di betulla	beech ash (IV) oak (IV) birch plywood	naturale noce biondo noce chiaro noce scuro sbiancato tortora grezzo	natural blond walnut light walnut dark walnut bleached dove grey unpolished	si/yes
—	—	—	multistrato di betulla laccato (opzionale) acciaio	lacquered birch plywood (optional) steel			
—	—	—	faggio frassino (IV) rovere (IV) multistrato di betulla	beech ash (IV) oak (IV) birch plywood	naturale noce biondo noce chiaro noce scuro sbiancato tortora grezzo	natural blond walnut light walnut dark walnut bleached dove grey unpolished	si/yes
—	—	—	multistrato di betulla laccato (opzionale) acciaio	lacquered birch plywood (optional) steel			

■ colore acciaio a scelta da mazzetta RAL/steel colour chosen on RAL swatch ▲ colore legno a campione/personalized wood shade
* solo struttura/structure only

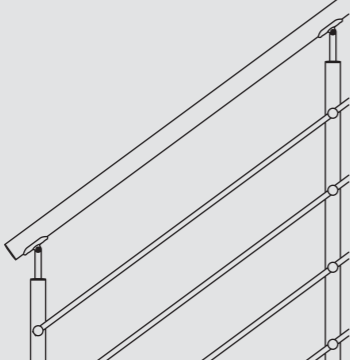
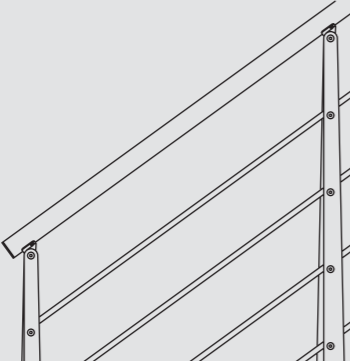
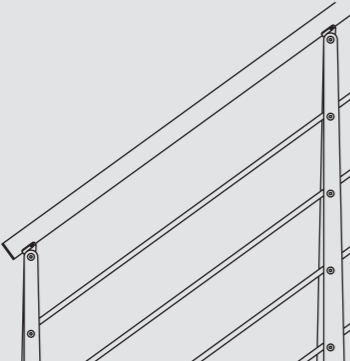
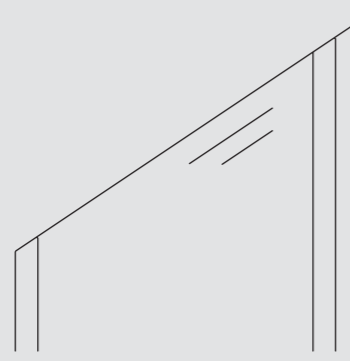
Scala/Staircase	Ringhiera/Railing	Materiali e colori	Materials and colours
LaFont Essential Fulmine R (p. 55) LaFont Essential Fascia R	050 B 	corrimano + colonnine D34 + fissaggi acciaio inox AISI 304: satinato struttura acciaio: bianco RAL 9010 (II) corten (II) grigio ghisa (II) grigio RAL 9006 (II) nero RAL 9005 (II) elementi orizzontali: tubini acciaio inox AISI 304 satinato	AISI 304 stainless steel handrail + D34 balusters + fixings: <i>satin</i> steel structure: white RAL 9010 (II) corten (II) iron grey (II) grey RAL 9006 (II) black RAL 9005 (II) horizontal elements: AISI 304 satin stainless steel tubes
LaFont Essential Fulmine R LaFont Essential Fascia R (p. 63)	060 B 	corrimano + fissaggi acciaio inox AISI 304: satinato colonnine doppio piatto + struttura acciaio: bianco RAL 9010 (II) corten (II) grigio ghisa (II) grigio RAL 9006 (II) nero RAL 9005 (II) elementi orizzontali: tubini acciaio inox AISI 304 satinato	AISI 304 stainless steel handrail + fixings: <i>satin</i> steel double plate balusters + structure: white RAL 9010 (II) corten (II) iron grey (II) grey RAL 9006 (II) black RAL 9005 (II) horizontal elements: AISI 304 satin stainless steel tubes
LaFont Essential Fulmine R LaFont Essential Fascia R (p. 65)	060 BX 	corrimano + colonnine doppio piatto + fissaggi acciaio inox AISI 304: satinato struttura acciaio: bianco RAL 9010 (II) corten (II) grigio ghisa (II) grigio RAL 9006 (II) nero RAL 9005 (II) elementi orizzontali: tubini acciaio inox AISI 304 satinato	AISI 304 stainless steel handrail + double plate balusters + fixings: <i>satin</i> steel structure: white RAL 9010 (II) corten (II) iron grey (II) grey RAL 9006 (II) black RAL 9005 (II) horizontal elements: AISI 304 satin stainless steel tubes
LaFont Essential Fulmine R LaFont Essential Fascia R (p. 59)	080 	pannelli metacrilato: trasparente piatti (50x8 mm) + struttura acciaio: bianco RAL 9010 (II) corten (II) grigio ghisa (II) grigio RAL 9006 (II) nero RAL 9005 (II)	methacrylate panels: <i>transparent</i> steel plates (50x8 mm) + structure: white RAL 9010 (II) corten (II) iron grey (II) grey RAL 9006 (II) black RAL 9005 (II)

Colori opzionali acciaio	Optional steel colours	■	Materiali gradini	Tread material	Tinte legno	Wood shades	▲
—	—	si/yes*	faggio frassino (IV) rovere (IV) multistrato di betulla multistrato di betulla laccato (opzionale) acciaio	beech ash (IV) oak (IV) birch plywood lacquered birch plywood (optional) steel	naturale noce biondo noce chiaro noce scuro sbiancato tortora grezzo	natural blond walnut light walnut dark walnut bleached dove grey unpolished	si/yes
—	—	si/yes**	faggio frassino (IV) rovere (IV) multistrato di betulla multistrato di betulla laccato (opzionale) acciaio	beech ash (IV) oak (IV) birch plywood lacquered birch plywood (optional) steel	naturale noce biondo noce chiaro noce scuro sbiancato tortora grezzo	natural blond walnut light walnut dark walnut bleached dove grey unpolished	si/yes
—	—	si/yes*	faggio frassino (IV) rovere (IV) multistrato di betulla multistrato di betulla laccato (opzionale) acciaio	beech ash (IV) oak (IV) birch plywood lacquered birch plywood (optional) steel	naturale noce biondo noce chiaro noce scuro sbiancato tortora grezzo	natural blond walnut light walnut dark walnut bleached dove grey unpolished	si/yes
—	—	si/yes	faggio frassino (IV) rovere (IV) multistrato di betulla multistrato di betulla laccato (opzionale) acciaio	beech ash (IV) oak (IV) birch plywood lacquered birch plywood (optional) steel	naturale noce biondo noce chiaro noce scuro sbiancato tortora grezzo	natural blond walnut light walnut dark walnut bleached dove grey unpolished	si/yes

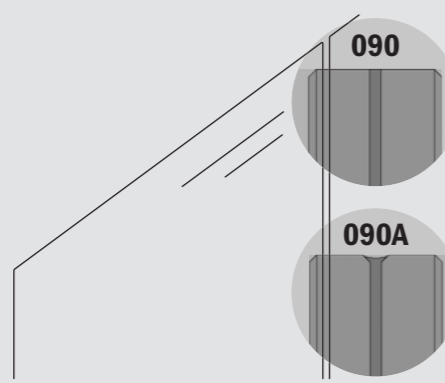
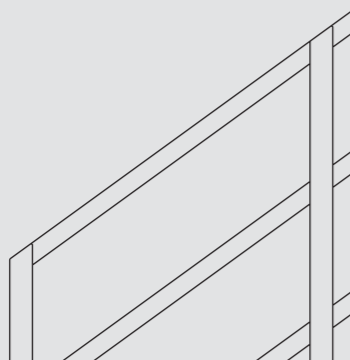
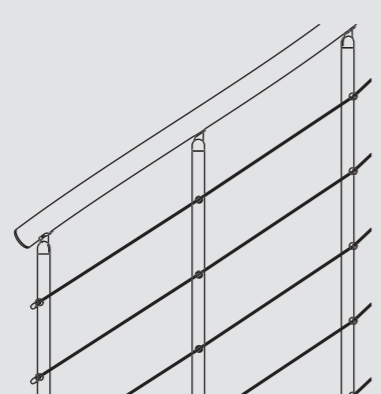
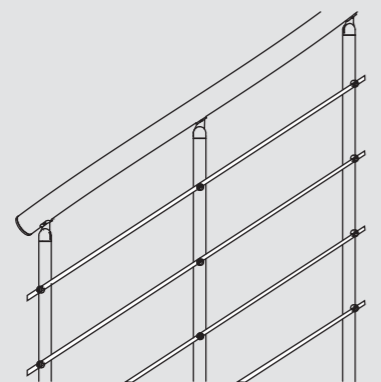
Scala/Staircase	Ringhiera/Railing	Materiali e colori	Materials and colours
LaFont Essential Fulmine R (p. 53) LaFont Essential Fascia R	090 090 A 	pannelli vetro: ringhiera 090: con bordi a filo lucido piatto rilavorati dopo l'accoppiamento vetro chiaro vetro extra chiaro ringhiera 090A: con bordi a filo lucido piatto vetro chiaro vetro extra chiaro struttura acciaio: bianco RAL 9010 (II) corten (II) grigio ghisa (II) grigio RAL 9006 (II) nero RAL 9005 (II) fissaggi acciaio inox AISI 304: rotules con finitura satinata	glass panels: railing 090: with a flat and polished edge reworked after couplin <i>clear glass</i> <i>extra-clear glass</i> railing 090A: with a flat polished edge <i>clear glass</i> <i>extra-clear glass</i> steel structure: white RAL 9010 (II) corten (II) iron grey (II) grey RAL 9006 (II) black RAL 9005 (II) AISI 304 stainless steel fixings: satin rotules
LaFont Essential Fulmine R (p. 57-61) LaFont Essential Fascia R	120 A 	corrimano + colonnine + elementi orizzontali piatti (40x8 mm) + struttura acciaio: bianco RAL 9010 (II) corten (II) grigio ghisa (II) grigio RAL 9006 (II) nero RAL 9005 (II)	steel handrail + balusters + horizontal plates (40x8 mm) + structure: white RAL 9010 (II) corten (II) iron grey (II) grey RAL 9006 (II) black RAL 9005 (II)
Mas R (p. 97)	010 A 	corrimano + colonnine D20 + struttura acciaio: bianco RAL 9010 (II) grigio ghisa (III) nero RAL 9005 (II) corrimano legno (opzionale): nelle essenze e tinte dei gradini fissaggi plastica: bianco RAL 9010 grigio ghisa nero RAL 9005 elementi orizzontali: tondini acciaio inox	steel handrail + D20 balusters + structure: white RAL 9010 (II) iron grey (III) black RAL 9005 (II) wood handrail (optional): <i>in matching materials and shades with the treads</i> plastic fixings: white RAL 9010 iron grey black RAL 9005 horizontal elements: stainless steel bars
Mas R (p. 99)	010 B 	corrimano + colonnine D20 + struttura acciaio: bianco RAL 9010 (II) grigio ghisa (III) nero RAL 9005 (II) corrimano legno (opzionale): nelle essenze e tinte dei gradini elementi orizzontali tubi PVC + fissaggi plastica: bianco RAL 9010 grigio ghisa nero RAL 9005	steel handrail + D20 balusters + structure: white RAL 9010 (II) iron grey (III) black RAL 9005 (II) wood handrail (optional): <i>in matching materials and shades with the treads</i> horizontal elements PVC tubes + plastic fixings: white RAL 9010 iron grey black RAL 9005

Colori opzionali acciaio	Optional steel colours	■	Materiali gradini	Tread material	Tinte legno	Wood shades	▲
—	—	si/yes*	faggio frassino (IV) rovere (IV) multistrato di betulla multistrato di betulla laccato (opzionale) acciaio	beech ash (IV) oak (IV) birch plywood lacquered birch plywood (optional) steel	naturale noce biondo noce chiaro noce scuro sbiancato tortora grezzo	natural blond walnut light walnut dark walnut bleached dove grey unpolished	si/yes
—	—	si/yes	faggio frassino (IV) rovere (IV) multistrato di betulla multistrato di betulla laccato (opzionale) acciaio (solo su strutture a doppio cosciale)	beech ash (IV) oak (IV) birch plywood lacquered birch plywood (optional) steel (only for double stringer structures)	naturale noce biondo noce chiaro noce scuro sbiancato tortora grezzo	natural blond walnut light walnut dark walnut bleached dove grey unpolished	si/yes
—	—	—	faggio frassino (IV) rovere (IV) multistrato di betulla	beech ash (IV) oak (IV) birch plywood	ardesia** naturale noce chiaro sbiancato colori opzionali: noce biondo noce scuro tortora	slate black** natural light walnut bleached optional colours: blond walnut dark walnut dove grey	si/yes
—	—	—	faggio frassino (IV) rovere (IV) multistrato di betulla	beech ash (IV) oak (IV) birch plywood	ardesia** naturale noce chiaro sbiancato colori opzionali: noce biondo noce scuro tortora	slate black** natural light walnut bleached optional colours: blond walnut dark walnut dove grey	si/yes

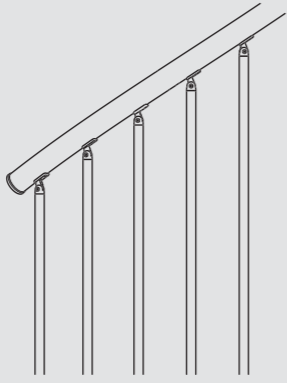
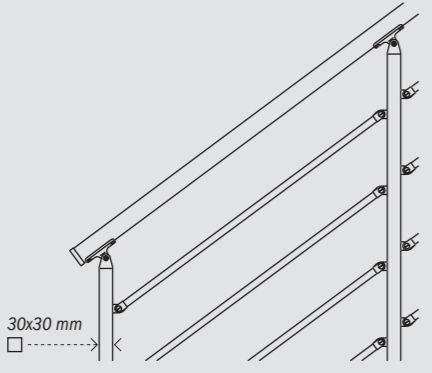
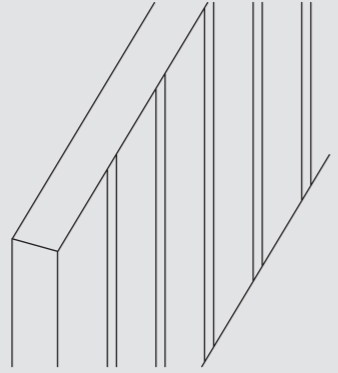
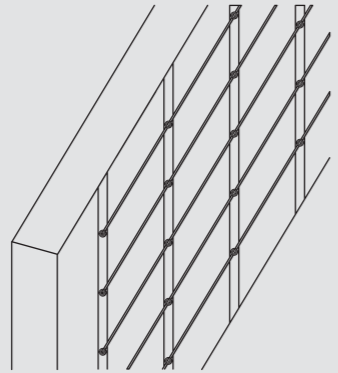
Scala/Staircase	Ringhiera/Railing	Materiali e colori	Materials and colours
Mas R	030 	corrimano + colonnine D20 + struttura acciaio: bianco RAL 9010 (II) grigio ghisa (III) nero RAL 9005 (II)	steel handrail + D20 balusters + structure: white RAL 9010 (II) iron grey (III) black RAL 9005 (II)
		corrimano legno (opzionale): nelle essenze e tinte dei gradini	wood handrail (optional): in matching materials and shades with the treads
		fissaggi plastica: bianco RAL 9010 grigio ghisa nero RAL 9005	plastic fixings: white RAL 9010 iron grey black RAL 9005
Oxa R Oxa Mini Oxa Light R	020 B 	corrimano + colonnine quadrate + fissaggi acciaio: bianco RAL 9010 (II) grigio RAL 9006 (II) nero RAL 9005 (II)	steel handrail + square section balusters + fixings: white RAL 9010 (II) grey RAL 9006 (II) black RAL 9005 (II)
		struttura legno: nelle essenze e tinte dei gradini	wood structure: in matching materials and shades with the treads
		elementi orizzontali tubi quadrati (15x15 mm) acciaio: bianco RAL 9010 (II) nero RAL 9005 (II) grigio RAL 9006 (II)	horizontal elements steel square section (15x15 mm) tubes: white RAL 9010 (II) grey RAL 9006 (II) black RAL 9005 (II)
Oxa R Oxa Mini Oxa Air R Oxa Light R (p. 101)	030 	corrimano + struttura legno: nelle essenze e tinte dei gradini	wood handrail + structure: in matching materials and shades with the treads
		colonnine D20 acciaio: bianco RAL 9010 (II) grigio ghisa (III) grigio RAL 9006 (II) nero RAL 9017 (I)	steel D20 balusters: white RAL 9010 (II) iron grey (III) grey RAL 9006 (II) black RAL 9017 (I)
Oxa R Oxa Mini	050 	corrimano + struttura legno: nelle essenze e tinte dei gradini	wood handrail + structure: in matching materials and shades with the treads
		colonnine D20 acciaio inox AISI 304: lucido	AISI 304 stainless steel D20 balusters: polished
		elementi orizzontali: tondini acciaio inox	horizontal elements: stainless steel bars

I - liscio-lucido/smooth-polished II - gofrato-opaco/embossed-matt III - liscio-opaco/smooth-matt IV - a richiesta spazzolato/brushed upon request

Colori opzionali acciaio	Optional steel colours	Materiali gradini	Tread material	Tinte legno	Wood shades	▲	
—	—	—	faggio frassino (IV) rovere (IV) multistrato di betulla	beech ash (IV) oak (IV) birch plywood	ardesia** naturale noce chiaro sbiancato	slate black** natural light walnut bleached	sì/yes
—	—	—	faggio (Oxa/Oxa Mini/ Oxa Light)	beech (Oxa/Oxa Mini/ Oxa Light)	naturale noce biondo noce chiaro noce scuro sbiancato tortora	natural blond walnut light walnut dark walnut bleached dove grey	sì/yes
—	—	—	frassino (Oxa/Oxa Mini)	ash (Oxa/Oxa Mini)	naturale noce biondo noce chiaro noce scuro sbiancato tortora	natural blond walnut light walnut dark walnut bleached dove grey	sì/yes
—	—	—	faggio (Oxa/Oxa Mini/Oxa Air/Oxa Light)	beech (Oxa/Oxa Mini/Oxa Air/Oxa Light)	naturale noce biondo noce chiaro noce scuro sbiancato tortora	natural blond walnut light walnut dark walnut bleached dove grey	sì/yes
—	—	—	frassino (Oxa/Oxa Mini/ Oxa Air)	ash (Oxa/Oxa Mini/ Oxa Air)	naturale noce biondo noce chiaro noce scuro sbiancato tortora	natural blond walnut light walnut dark walnut bleached dove grey	sì/yes
—	—	—	faggio frassino	beech ash	naturale noce biondo noce chiaro noce scuro sbiancato tortora	natural blond walnut light walnut dark walnut bleached dove grey	sì/yes

■ colore acciaio a scelta da mazzetta RAL/steel colour chosen on RAL swatch

▲ colore legno a campione/personalized wood shade

** a richiesta/on demand

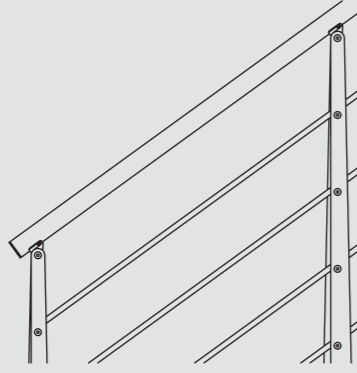
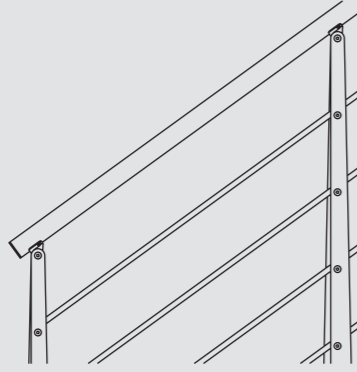
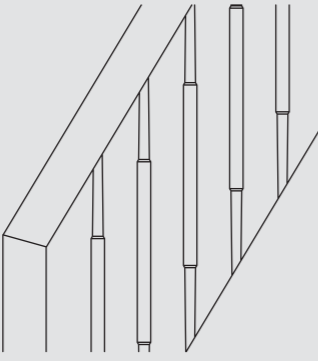
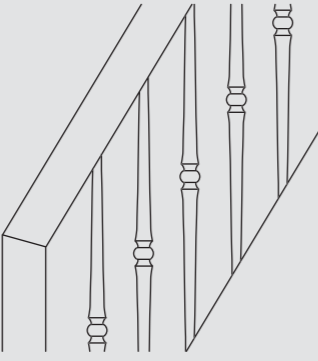
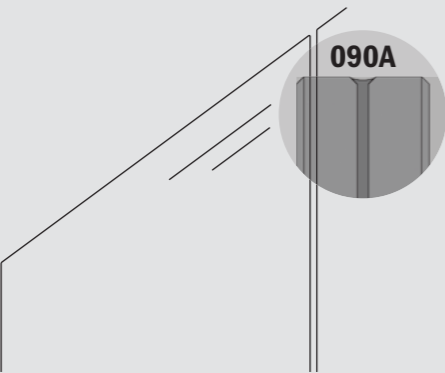
Scala/Staircase	Ringhiera/Railing	Materiali e colori	Materials and colours
Oxa R Oxa Mini Oxa Air R	060 B 	corrimano + fissaggi acciaio inox AISI 304: satinato colonnine doppio piatto acciaio: bianco RAL 9010 (II) grigio ghisa (III) grigio RAL 9006 (II) nero RAL 9005 (II) struttura legno: nelle essenze e tinte dei gradini elementi orizzontali: tubini acciaio inox AISI 304 satinato	AISI 304 stainless steel handrail + fixings: satin steel double plate balusters: white RAL 9010 (II) iron grey (III) grey RAL 9006 (II) black RAL 9005 (II) wood structure: in matching materials and shades with the treads horizontal elements: AISI 304 satin stainless steel tubes
Oxa R Oxa Mini Oxa Air R	060 BX 	corrimano + colonnine doppio piatto + fissaggi acciaio inox AISI 304: satinato struttura legno: nelle essenze e tinte dei gradini elementi orizzontali: tubini acciaio inox AISI 304 satinato	AISI 304 stainless steel handrail + double plate balusters + fixings: satin wood structure: in matching materials and shades with the treads horizontal elements: AISI 304 satin stainless steel tubes
Oxa R Oxa Mini (p. 127) Oxa Light R	070 A 	corrimano + colonnine + struttura legno: nelle essenze e tinte dei gradini	wood handrail + balusters + structure: in matching materials and shades with the treads
Oxa R (p. 131) Oxa Mini	070 B 	corrimano + colonnine + struttura legno: nelle essenze e tinte dei gradini	wood handrail + balusters + structure: in matching materials and shades with the treads
Oxa R Oxa Mini Oxa Air R (p. 103)	090 A 	pannelli vetro: con bordi a filo lucido piatto chiaro extra chiaro struttura legno: nelle essenze e tinte dei gradini fissaggi acciaio inox AISI 304: rotules con finitura satinata	glass panels: with a flat polished edge clear extra-clear wood structure: in matching materials and shades with the treads AISI 304 stainless steel fixings: satin rotules

Colori opzionali acciaio	Optional steel colours	■	Materiali gradini	Tread material	Tinte legno	Wood shades	▲
—	—	si/yes*	faggio frassino	beech ash	naturale noce biondo noce chiaro noce scuro sbiancato tortora	natural blond walnut light walnut dark walnut bleached dove grey	si/yes
—	—	—	faggio frassino	beech ash	naturale noce biondo noce chiaro noce scuro sbiancato tortora	natural blond walnut light walnut dark walnut bleached dove grey	si/yes
—	—	—	faggio (Oxa/Oxa Mini/Oxa Light) frassino (Oxa/Oxa Mini)	beech (Oxa/Oxa Mini/Oxa Light) ash (Oxa/Oxa Mini)	naturale noce biondo noce chiaro noce scuro sbiancato tortora	natural blond walnut light walnut dark walnut bleached dove grey	si/yes
—	—	—	faggio (Oxa/Oxa Mini/Oxa Light) frassino (Oxa/Oxa Mini)	beech (Oxa/Oxa Mini/Oxa Light) ash (Oxa/Oxa Mini)	naturale noce biondo noce chiaro noce scuro sbiancato tortora	natural blond walnut light walnut dark walnut bleached dove grey	si/yes
—	—	—	faggio frassino	beech ash	naturale noce biondo noce chiaro noce scuro sbiancato tortora	natural blond walnut light walnut dark walnut bleached dove grey	si/yes

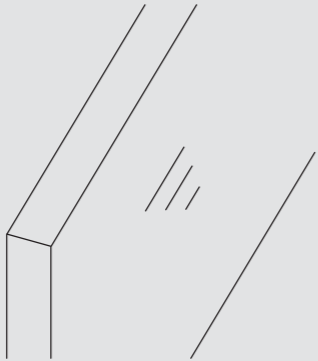
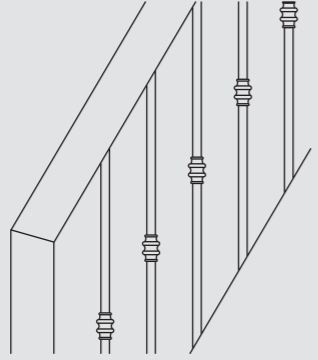
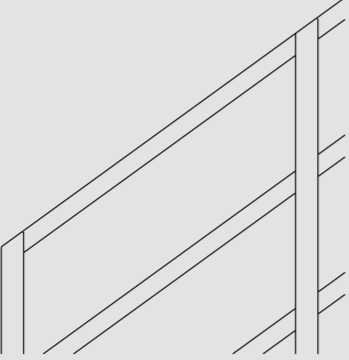
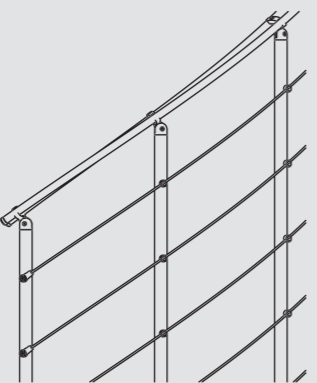
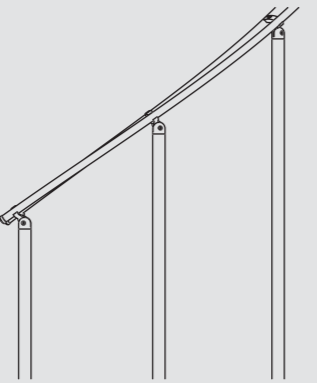
Scala/Staircase	Ringhiera/Railing	Materiali e colori	Materials and colours
Oxa R	090 B 	pannelli vetro: decorato trasparente	glass panels: decorated transparent
		corrimano + struttura legno: nelle essenze e tinte dei gradini	wood handrail + structure: in matching materials and shades with the treads
Oxa R (p. 131) Oxa Mini Oxa Air R Oxa Light R	110 	corrimano + struttura legno: nelle essenze e tinte dei gradini	wood handrail + structure: in matching materials and shades with the treads
		colonnine D20 + decori acciaio: grigio ghisa (III)	steel D20 balusters + decorations: iron grey (III)
Oxa R Oxa Mini Oxa Light R	120 A 	corrimano + colonnine + elementi orizzontali piatti (40x8 mm) acciaio: bianco RAL 9010 (II) grigio ghisa (II) grigio RAL 9006 (II) nero RAL 9005 (II)	steel handrail + balusters + horizontal plates (40x8 mm): white RAL 9010 (II) iron grey (III) grey RAL 9006 (II) black RAL 9005 (II)
		struttura legno: nelle essenze e tinte dei gradini	wood structure: in matching materials and shades with the treads
Slim T	010 A 	colonnine D27 + struttura + fissaggi acciaio: grigio ghisa (III) nero RAL 9005 (II) bianco RAL 9010 (II) grigio RAL 9006 (II)	steel D27 balusters + structure + fixings: iron grey (III) black RAL 9005 (II) white RAL 9010 (II) grey RAL 9006 (II)
		corrimano doppio D16 alluminio: grigio ghisa (III) nero RAL 9005 (II) bianco RAL 9010 (II) grigio RAL 9006 (II)	aluminium D16 double handrail: iron grey (III) black RAL 9005 (II) white RAL 9010 (II) grey RAL 9006 (II)
		elementi orizzontali: tondini acciaio inox	horizontal elements: stainless steel bars
Slim T (p. 71)	030 	colonnine D27 + struttura + fissaggi acciaio: grigio ghisa (III) nero RAL 9005 (II) bianco RAL 9010 (II) grigio RAL 9006 (II)	steel D27 balusters + structure + fixings: iron grey (III) black RAL 9005 (II) white RAL 9010 (II) grey RAL 9006 (II)
		corrimano doppio D16 alluminio: grigio ghisa (III) nero RAL 9005 (II) bianco RAL 9010 (II) grigio RAL 9006 (II)	aluminium D16 double handrail: iron grey (III) black RAL 9005 (II) white RAL 9010 (II) grey RAL 9006 (II)

I - liscio-lucido/smooth-polished II - gofrato-opaco/embossed-matt III - liscio-opaco/smooth-matt IV - a richiesta spazzolato/brushed upon request

Colori opzionali acciaio	Optional steel colours	■	Materiali gradini	Tread material	Tinte legno	Wood shades	▲
–	–	–	faggio frassino	beech ash	naturale noce biondo noce chiaro noce scuro sbiancato tortora	natural blond walnut light walnut dark walnut bleached dove grey	si/yes
–	–	–	faggio (Oxa/Oxa Mini/ Oxa Air/Oxa Light)	beech (Oxa/Oxa Mini/ Oxa Air/Oxa Light)	naturale noce biondo noce chiaro noce scuro sbiancato tortora	natural blond walnut light walnut dark walnut bleached dove grey	si/yes
–	–	si/yes *	frassino (Oxa/Oxa Mini/ Oxa Air)	ash (Oxa/Oxa Mini/ Oxa Air)	naturale noce biondo noce chiaro noce scuro sbiancato tortora	natural blond walnut light walnut dark walnut bleached dove grey	si/yes
bianco ghiaccio RAL 9003 (III) bianco panna RAL 9001 (III) corten (II)	cool white RAL 9003 (III) off white RAL 9001 (III) corten (II)	–	faggio (Oxa/Oxa Mini/ Oxa Light)	beech (Oxa/Oxa Mini/ Oxa Light)	naturale noce biondo noce chiaro noce scuro sbiancato tortora	natural blond walnut light walnut dark walnut bleached dove grey	–
–	–	–	frassino (Oxa/Oxa Mini)	ash (Oxa/Oxa Mini)	naturale noce biondo noce chiaro noce scuro sbiancato tortora	natural blond walnut light walnut dark walnut bleached dove grey	–
bianco ghiaccio RAL 9003 (III) bianco panna RAL 9001 (III) corten (II)	cool white RAL 9003 (III) off white RAL 9001 (III) corten (II)	–	acciaio	steel	naturale noce biondo noce chiaro noce scuro sbiancato tortora	natural blond walnut light walnut dark walnut bleached dove grey	–
–	–	–	gradini in legno di recupero (opzionale)	recycled wood tread (optional)	naturale noce biondo noce chiaro noce scuro sbiancato tortora	natural blond walnut light walnut dark walnut bleached dove grey	–
bianco ghiaccio RAL 9003 (III) bianco panna RAL 9001 (III) corten (II)	cool white RAL 9003 (III) off white RAL 9001 (III) corten (II)	–	acciaio	steel	naturale noce biondo noce chiaro noce scuro sbiancato tortora	natural blond walnut light walnut dark walnut bleached dove grey	–
–	–	–	gradini in legno di recupero (opzionale)	recycled wood tread (optional)	naturale noce biondo noce chiaro noce scuro sbiancato tortora	natural blond walnut light walnut dark walnut bleached dove grey	–

■ colore acciaio a scelta da mazzetta RAL/steel colour chosen on RAL swatch

* solo ringhiera/railing only

▲ colore legno a campione/personalized wood shade

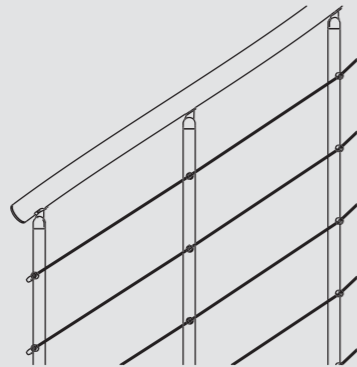
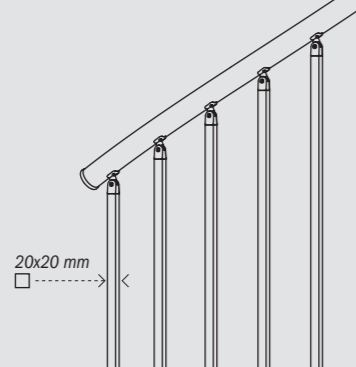
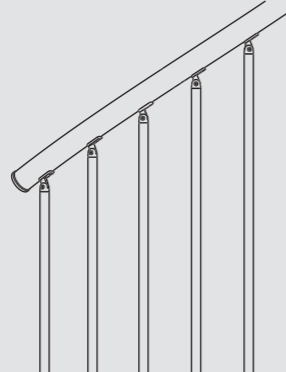
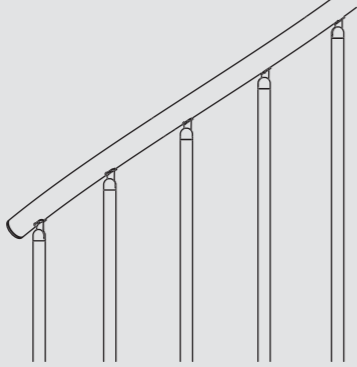
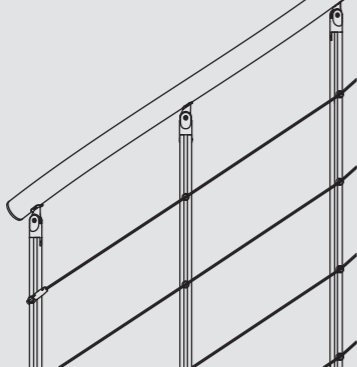
Scala/Staircase	Ringhiera/Railing	Materiali e colori	Materials and colours
Unika R	010 	corrimano + struttura legno: nelle tinte dei gradini colonnine D27 + fissaggi acciaio: bianco RAL 9010 (II) cromo (I) grigio ghisa (III) grigio RAL 9006 (II) nero ramato (III) elementi orizzontali: cavi acciaio inox	wood handrail + structure: <i>in matching shades with the treads</i> steel D27 balusters + fixings: <i>white RAL 9010 (II)</i> <i>chrome (I)</i> <i>iron grey (III)</i> <i>grey RAL 9006 (II)</i> <i>coppery black (III)</i> horizontal elements: <i>stainless steel cables</i>
Unika R	020 	corrimano + struttura legno: nelle tinte dei gradini colonnine quadrate acciaio: bianco RAL 9010 (II) cromo (I) grigio ghisa (III) grigio RAL 9006 (II) nero ramato (III)	wood handrail + structure: <i>in matching shades with the treads</i> steel square section balusters: <i>white RAL 9010 (II)</i> <i>chrome (I)</i> <i>iron grey (III)</i> <i>grey RAL 9006 (II)</i> <i>coppery black (III)</i>
Unika R (p. 105)	030 	corrimano + struttura legno: nelle tinte dei gradini colonnine D20 acciaio: bianco RAL 9010 (II) cromo (I) grigio ghisa (III) grigio RAL 9006 (II) nero ramato (III)	wood handrail + structure: <i>in matching shades with the treads</i> steel D20 balusters: <i>white RAL 9010 (II)</i> <i>chrome (I)</i> <i>iron grey (III)</i> <i>grey RAL 9006 (II)</i> <i>coppery black (III)</i>
Unika R	030 A 	corrimano + struttura legno: nelle tinte dei gradini colonnine D27 + fissaggi acciaio: bianco RAL 9010 (II) cromo (I) grigio ghisa (III) grigio RAL 9006 (II) nero ramato (III) elementi orizzontali: cavi acciaio inox	wood handrail + structure: <i>in matching shades with the treads</i> steel D27 balusters + fixings: <i>white RAL 9010 (II)</i> <i>chrome (I)</i> <i>iron grey (III)</i> <i>grey RAL 9006 (II)</i> <i>coppery black (III)</i> horizontal elements: <i>stainless steel cables</i>
Unika R (p. 109)	040 	corrimano + struttura legno: nelle tinte dei gradini colonnine D27 + fissaggi alluminio: anodizzato elementi orizzontali: cavi acciaio inox	wood handrail + structure: <i>in matching shades with the treads</i> aluminium D27 balusters + fixings: <i>anodized</i> horizontal elements: <i>stainless steel cables</i>

Colori opzionali acciaio	Optional steel colours	■	Materiale gradini	Tread material	Tinte legno	Wood shades	▲
—	—	—	multistrato di betulla	<i>birch plywood</i>	naturale noce biondo noce chiaro noce scuro sbiancato tortora	<i>natural blond walnut light walnut dark walnut bleached dove grey</i>	si/yes
—	—	—	multistrato di betulla laminato bianco	<i>white laminated natural birch plywood</i>	naturale noce biondo noce chiaro noce scuro sbiancato tortora	<i>natural blond walnut light walnut dark walnut bleached dove grey</i>	si/yes
—	—	—	faggio	<i>beech</i>	naturale noce biondo noce chiaro noce scuro sbiancato tortora	<i>natural blond walnut light walnut dark walnut bleached dove grey</i>	si/yes
—	—	—	frassino	<i>ash</i>	naturale noce biondo noce chiaro noce scuro sbiancato tortora	<i>natural blond walnut light walnut dark walnut bleached dove grey</i>	si/yes
—	—	—	rovere	<i>oak</i>	naturale noce biondo noce chiaro noce scuro sbiancato tortora	<i>natural blond walnut light walnut dark walnut bleached dove grey</i>	si/yes
—	—	—	multistrato di betulla	<i>birch plywood</i>	naturale noce biondo noce chiaro noce scuro sbiancato tortora	<i>natural blond walnut light walnut dark walnut bleached dove grey</i>	si/yes
—	—	—	multistrato di betulla laminato bianco	<i>white laminated natural birch plywood</i>	naturale noce biondo noce chiaro noce scuro sbiancato tortora	<i>natural blond walnut light walnut dark walnut bleached dove grey</i>	si/yes
—	—	—	faggio	<i>beech</i>	naturale noce biondo noce chiaro noce scuro sbiancato tortora	<i>natural blond walnut light walnut dark walnut bleached dove grey</i>	si/yes
—	—	—	frassino	<i>ash</i>	naturale noce biondo noce chiaro noce scuro sbiancato tortora	<i>natural blond walnut light walnut dark walnut bleached dove grey</i>	si/yes
—	—	—	rovere	<i>oak</i>	naturale noce biondo noce chiaro noce scuro sbiancato tortora	<i>natural blond walnut light walnut dark walnut bleached dove grey</i>	si/yes

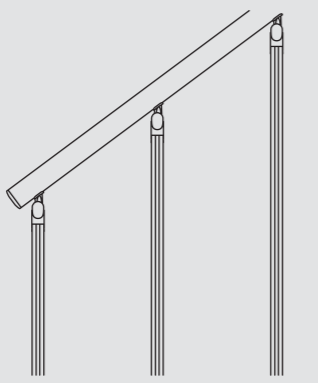
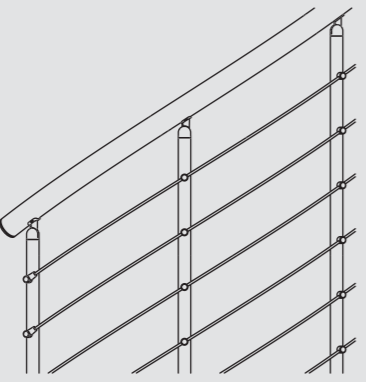
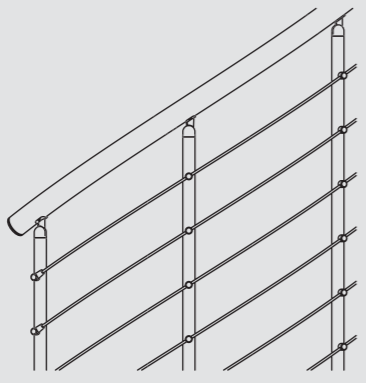
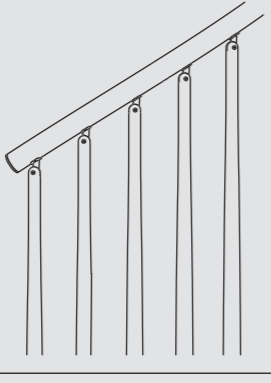
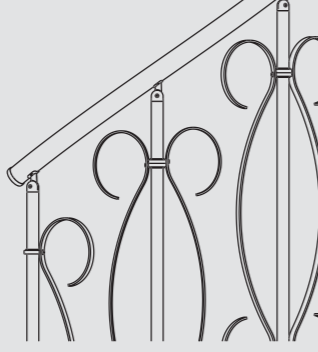
Scala/Staircase	Ringhiera/Railing	Materiali e colori	Materials and colours
Unika R	040 A 	<p>corrimano + struttura legno: nelle tinte dei gradini</p> <p>colonnine D27 + fissaggi alluminio: anodizzato</p>	<p>wood handrail + structure: in matching shades with the treads</p> <p>aluminium D27 balusters + fixings: anodized</p>
Unika R	050 	<p>corrimano + struttura legno: nelle tinte dei gradini</p> <p>colonnine D27 acciaio inox AISI 304: lucido</p> <p>fissaggi acciaio: nichel satinato (III)</p> <p>elementi orizzontali: tondini acciaio inox</p>	<p>wood handrail + structure: in matching shades with the treads</p> <p>AISI 304 stainless steel balusters: polished</p> <p>steel fixings: satin nickel-plated (III)</p> <p>horizontal elements: stainless steel bars</p>
Unika R	050 A 	<p>corrimano + struttura legno: nelle tinte dei gradini</p> <p>colonnine D27 + fissaggi acciaio: nichel satinato (III)</p> <p>elementi orizzontali: tondini acciaio inox</p>	<p>wood handrail + structure: in matching shades with the treads</p> <p>steel D27 balusters + fixings: satin nickel-plated (III)</p> <p>horizontal elements: stainless steel bars</p>
Unika R	070 	<p>corrimano + struttura + colonnine legno: nelle tinte dei gradini</p> <p>fissaggi acciaio: bianco RAL 9010 (II) cromo (I) grigio ghisa (III) grigio RAL 9006 (II) nero ramato (III)</p>	<p>wood handrail + structure + balusters: in matching shades with the treads</p> <p>steel fixings: white RAL 9010 (II) chrome (I) iron grey (III) grey RAL 9006 (II) coppery black (III)</p>
Unique T (p. 119)	110 	<p>corrimano PVC con anima alluminio: grigio RAL 7016</p> <p>colonnine D27 + decori + struttura + fissaggi acciaio: grigio RAL 7016 (III)</p>	<p>PVC handrail with aluminium core: grey RAL 7016</p> <p>steel D27 balusters + decorations + structure + fixings: grey RAL 7016 (III)</p>

I - liscio-lucido/smooth-polished II - gofrato-opaco/embossed-matt III - liscio-opaco/smooth-matt IV - a richiesta spazzolato/brushed upon request

Colori opzionali acciaio	Optional steel colours	■	Materiali gradini	Tread material	Tinte legno	Wood shades	▲
—	—	—	multistrato di betulla	<i>birch plywood</i>	naturale noce biondo noce chiaro noce scuro sbiancato tortora	<i>natural blond walnut light walnut dark walnut bleached dove grey</i>	si/yes
—	—	—	multistrato di betulla laminato bianco	<i>white laminated natural birch plywood</i>	naturale noce biondo noce chiaro noce scuro sbiancato tortora	<i>natural blond walnut light walnut dark walnut bleached dove grey</i>	si/yes
—	—	—	faggio	<i>beech</i>			
—	—	—	frassino	<i>ash</i>			
—	—	—	rovere	<i>oak</i>			
—	—	—	multistrato di betulla	<i>birch plywood</i>	naturale noce biondo noce chiaro noce scuro sbiancato tortora	<i>natural blond walnut light walnut dark walnut bleached dove grey</i>	si/yes
—	—	—	multistrato di betulla laminato bianco	<i>white laminated natural birch plywood</i>	naturale noce biondo noce chiaro noce scuro sbiancato tortora	<i>natural blond walnut light walnut dark walnut bleached dove grey</i>	si/yes
—	—	—	faggio	<i>beech</i>			
—	—	—	frassino	<i>ash</i>			
—	—	—	rovere	<i>oak</i>			
bianco RAL 9010 (I)	<i>white RAL 9010 (I)</i>	—	acciaio	<i>steel</i>	—	—	—

■ colore acciaio a scelta da mazzetta RAL/steel colour chosen on RAL swatch ▲ colore legno a campione/personalized wood shade

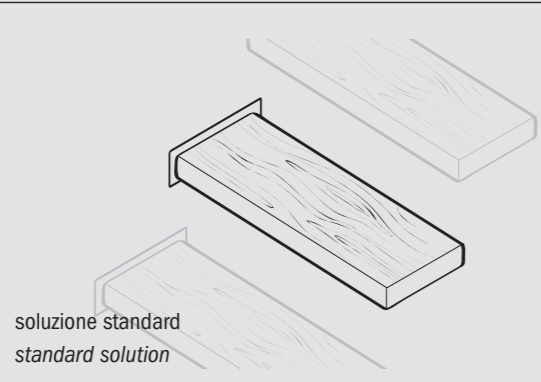
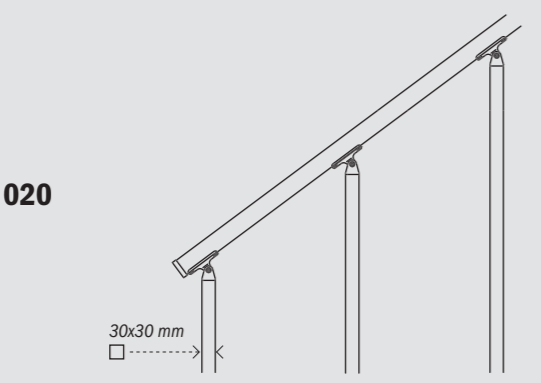
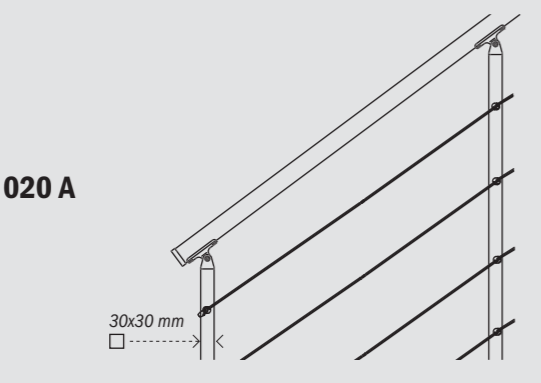
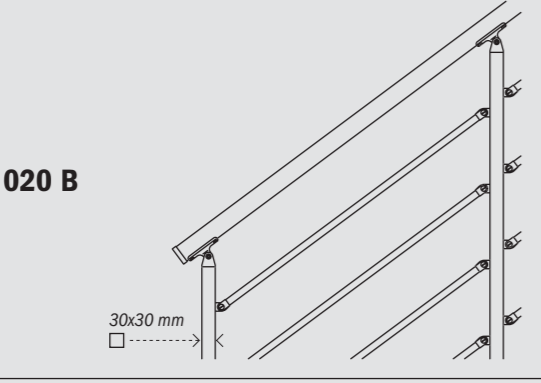
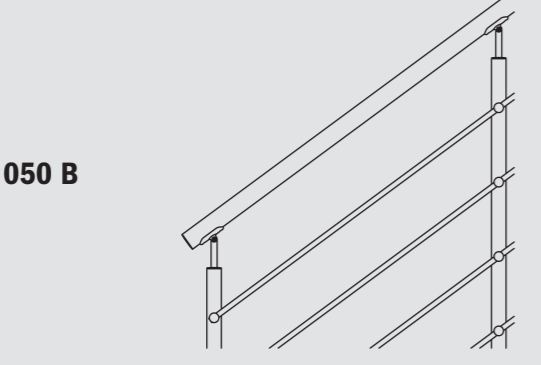
Scala/Staircase	Ringhiera/Railing	Materiali e colori	Materials and colours
Wall (p. 33)	 soluzione standard standard solution	struttura acciaio: bianco RAL 9010 (II)	steel structure: white RAL 9010 (II)
Wall	020  30x30 mm	corrimano + colonnine quadrate + fissaggi acciaio: bianco RAL 9010 (II) nero RAL 9005 (II) grigio RAL 9006 (II) struttura acciaio: bianco RAL 9010 (II)	steel handrail + square section balusters + fixings: white RAL 9010 (II) black RAL 9005 (II) grey RAL 9006 (II) steel structure: white RAL 9010 (II)
Wall	020 A  30x30 mm	corrimano + colonnine quadrate + fissaggi acciaio: bianco RAL 9010 (II) nero RAL 9005 (II) grigio RAL 9006 (II) struttura acciaio: bianco RAL 9010 (II) elementi orizzontali: cavi acciaio inox	steel handrail + square section balusters + fixings: white RAL 9010 (II) black RAL 9005 (II) grey RAL 9006 (II) steel structure: white RAL 9010 (II) horizontal elements: stainless steel cables
Wall	020 B  30x30 mm	corrimano + colonnine quadrate + fissaggi acciaio: bianco RAL 9010 (II) nero RAL 9005 (II) grigio RAL 9006 (II) elementi orizzontali tubi quadrati (15x15 mm) acciaio: bianco RAL 9010 (II) nero RAL 9005 (II) grigio RAL 9006 (II) struttura acciaio: bianco RAL 9010 (II)	steel handrail + square section balusters + fixings: white RAL 9010 (II) black RAL 9005 (II) grey RAL 9006 (II) horizontal elements steel square section (15x15 mm) tubes: white RAL 9010 (II) black RAL 9005 (II) grey RAL 9006 (II) steel structure: white RAL 9010 (II)
Wall	050 B 	corrimano + colonnine D34 + fissaggi acciaio inox AISI 304: satinato struttura acciaio: bianco RAL 9010 (II) elementi orizzontali: tubini acciaio inox AISI 304 satinato	AISI 304 stainless steel handrail + D34 balusters + fixings: satin steel structure: white RAL 9010 (II) horizontal elements: AISI 304 satin stainless steel tubes

I - liscio-lucido/smooth-polished II - gofrato-opaco/embossed-matt III - liscio-opaco/smooth-matt IV - a richiesta spazzolato/brushed upon request

Colori opzionali acciaio	Optional steel colours	■	Materiali gradini	Tread material	Tinte legno	Wood shades	▲
—	—	—	faggio frassino rovere	beech ash oak	naturale noce biondo noce chiaro noce scuro sbiancato tortora	natural blond walnut light walnut dark walnut bleached dove grey	si/yes
—	—	—	faggio frassino rovere	beech ash oak	naturale noce biondo noce chiaro noce scuro sbiancato tortora	natural blond walnut light walnut dark walnut bleached dove grey	si/yes
—	—	—	faggio frassino rovere	beech ash oak	naturale noce biondo noce chiaro noce scuro sbiancato tortora	natural blond walnut light walnut dark walnut bleached dove grey	si/yes
—	—	—	faggio frassino rovere	beech ash oak	naturale noce biondo noce chiaro noce scuro sbiancato tortora	natural blond walnut light walnut dark walnut bleached dove grey	si/yes
—	—	—	faggio frassino rovere	beech ash oak	naturale noce biondo noce chiaro noce scuro sbiancato tortora	natural blond walnut light walnut dark walnut bleached dove grey	si/yes

■ colore acciaio a scelta da mazzetta RAL/steel colour chosen on RAL swatch ▲ colore legno a campione/personalized wood shade

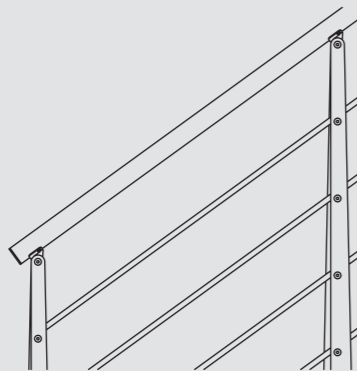
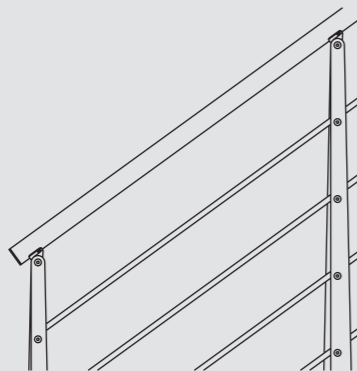
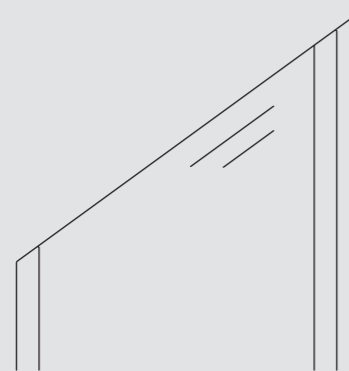
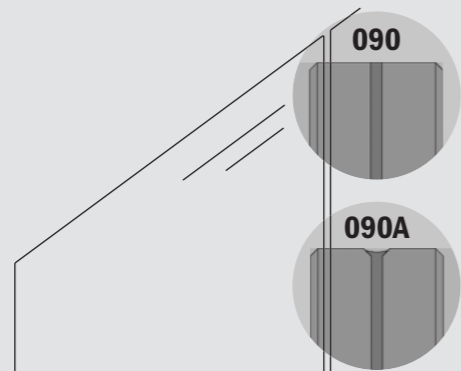
Scala/Staircase	Ringhiera/Railing	Materiali e colori	Materials and colours
Wall (p. 35)	060 B 	corrimano + fissaggi acciaio inox AISI 304: satinato colonnine doppio piatto acciaio: bianco RAL 9010 (II) corten (II) grigio ghisa (II) grigio RAL 9006 (II) nero RAL 9005 (II) struttura acciaio: bianco RAL 9010 (II) elementi orizzontali: tubini acciaio inox AISI 304 satinato	AISI 304 stainless steel handrail + fixings: satin steel double plate balusters: white RAL 9010 (II) corten (II) iron grey (II) grey RAL 9006 (II) black RAL 9005 (II) steel structure: white RAL 9010 (II) horizontal elements: AISI 304 satin stainless steel tubes
Wall	060 BX 	corrimano + colonnine doppio piatto + fissaggi acciaio inox AISI 304: satinato struttura acciaio: bianco RAL 9010 (II) elementi orizzontali: tubini acciaio inox AISI 304 satinato	AISI 304 stainless steel handrail + double plate balusters + fixings: satin steel structure: white RAL 9010 (II) horizontal elements: AISI 304 satin stainless steel tubes
Wall	080 	pannelli metacrilato: trasparente struttura acciaio: bianco RAL 9010 (II) piatti (50x8 mm) acciaio: bianco RAL 9010 (II) corten (II) grigio ghisa (II) grigio RAL 9006 (II) nero RAL 9005 (II)	methacrylate panels: transparent steel structure: white RAL 9010 (II) steel (50x8 mm) plates: white RAL 9010 (II) corten (II) iron grey (II) grey RAL 9006 (II) black RAL 9005 (II)
Wall (p. 37)	090 090 A 	pannelli vetro: ringhiera 090: con bordi a filo lucido piatto rilavorati dopo l'accoppiamento vetro chiaro vetro extra chiaro ringhiera 090A: con bordi a filo lucido piatto vetro chiaro vetro extra chiaro struttura acciaio: bianco RAL 9010 (II) fissaggi acciaio inox AISI 304: rotules con finitura satinata	glass panels: railing 090: with a flat and polished edge reworked after couplin clear glass extra-clear glass railing 090A: with a flat polished edge clear glass extra-clear glass steel structure: white RAL 9010 (II) AISI 304 stainless steel fixings: satin rotules

I - liscio-lucido/smooth-polished II - gofrato-opaco/embossed-matt III - liscio-opaco/smooth-matt IV - a richiesta spazzolato/brushed upon request

Colori opzionali acciaio	Optional steel colours	■	Materiali gradini	Tread material	Tinte legno	Wood shades	▲
—	—	si/yes*	faggio frassino rovere	beech ash oak	naturale noce biondo noce chiaro noce scuro sbiancato tortora	natural blond walnut light walnut dark walnut bleached dove grey	si/yes
—	—	si/yes	faggio frassino rovere	beech ash oak	naturale noce biondo noce chiaro noce scuro sbiancato tortora	natural blond walnut light walnut dark walnut bleached dove grey	si/yes
—	—	si/yes*	faggio frassino rovere	beech ash oak	naturale noce biondo noce chiaro noce scuro sbiancato tortora	natural blond walnut light walnut dark walnut bleached dove grey	si/yes
—	—	—	faggio frassino rovere	beech ash oak	naturale noce biondo noce chiaro noce scuro sbiancato tortora	natural blond walnut light walnut dark walnut bleached dove grey	si/yes

■ colore acciaio a scelta da mazzetta RAL/steel colour chosen on RAL swatch

* solo piatti/plates only

▲ colore legno a campione/personalized wood shade

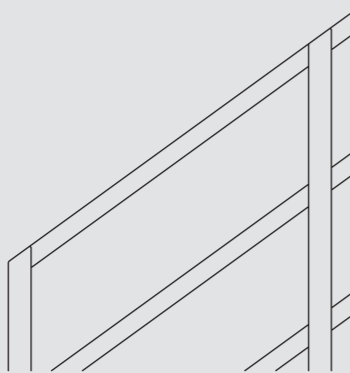
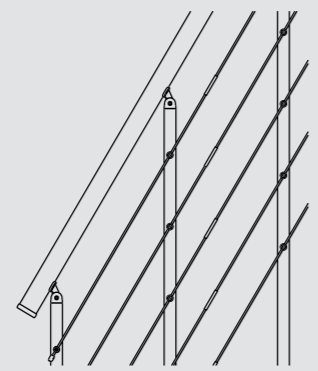
Scala/Staircase	Ringhiera/Railing	Materiali e colori	Materials and colours
Wall	120 A 	corrimano + colonnine + elementi orizzontali piatti acciaio (40x8 mm): bianco RAL 9010 (II) corten (II) grigio ghisa (II) grigio RAL 9006 (II) nero RAL 9005 (II)	steel handrail + balusters horizontal plates (40x8 mm): white RAL 9010 (II) corten (II) iron grey (II) grey RAL 9006 (II) black RAL 9005 (II)
		struttura acciaio: bianco RAL 9010 (II)	steel structure: white RAL 9010 (II)
Zen (p. 125)	010 A 	corrimano legno: nelle tinte dei gradini	wood handrail: in matching shades with the treads
		colonnine D27 + struttura + fissaggi acciaio: bianco RAL 9010 (I) grigio RAL 9006 (II) nero RAL 9005 (II)	steel D27 balusters + structure + fixings: white RAL 9010 (I) grey RAL 9006 (II) black RAL 9005 (II)
		elementi orizzontali: tondini acciaio inox	horizontal elements: stainless steel bars
Diva (p. 15)	a progetto/custom-designed		
Twist (p. 25)	a progetto/custom-designed		
Minimized T (p. 23) Minimized R	a progetto/custom-designed		

Colori opzionali acciaio	Optional steel colours	■	Materiali gradini	Tread material	Tinte legno	Wood shades	▲
—	—	sì/yes*	faggio frassino rovere	beech ash oak	naturale noce biondo noce chiaro noce scuro sbiancato tortora	natural blond walnut light walnut dark walnut bleached dove grey	sì/yes
—	—	—	faggio	beech	naturale noce scuro sbiancato coprente tortora	natural dark walnut opaque bleached dove grey	—

**Test di resistenza strutturale della scala/
Staircase structural strength test**
EN 1991-1-1:2002
CEN/TS 15680:2007

A $q_{RK} = 4 \text{ [kN/m}^2] \approx 400 \text{ [kg/m}^2]$
forza verticale distribuita applicata uniformemente sul gradino e contemporaneamente su tutti i gradini/
distributed vertical force applied evenly and simultaneously on all the treads

B $Q_{RK} = 4 \text{ [kN]} \approx 400 \text{ [kg]}$
forza concentrata verticale applicata nel punto più sfavorevole/
concentrated vertical force applied to the most unfavourable point

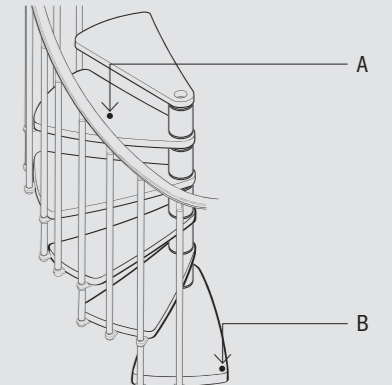
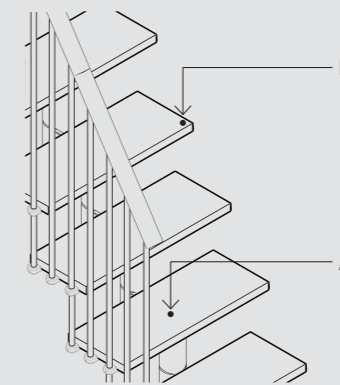

Progetto ideato da
ufficio comunicazione Fontanot/
Project designed by
Fontanot Communication Office

Styling:
Alessandra Laudati

Si ringrazia/
Thanks to:
Wall&decò
Refin
14oraitaliana

I prodotti illustrati sono soggetti ad una costante verifica dei particolari funzionali ed a una continua ricerca tecnologica sui trattamenti di finitura.

Tutte le foto e le immagini contenute in questo catalogo sono di proprietà di Fontanot S.p.A.

NUMERO VERDE

800.847021

per i punti vendita della tua città.

The products illustrated herein are subject to constant revision in terms of their functional details and undergo continuous research as to the finishing treatments applied.

All pictures and images included in this catalogue are the property of Fontanot S.p.A.

I prodotti rappresentati nella presente pubblicazione, nonché le descrizioni e le caratteristiche tecniche riportate, sono indicativi e possono essere soggetti a modifiche senza preavviso da parte di Fontanot S.p.A. Si consiglia di verificare le caratteristiche del prodotto presso i punti vendita.

The products depicted in this catalogue, including the relative descriptions and technical features, are purely indicative and may be subject to change without prior notice by Fontanot S.p.A. We suggest verifying the product's features at the sales outlets.

Fontanot S.p.A.
Sede legale ed amministrativa
Registered and administrative office

via P. Paolo Pasolini, 6
47853 Cerasolo Ausa
Rimini, Italy

tel. +39.0541.90.61.11
fax +39.0541.90.61.24
info@fontanot.it
www.fontanot.it



LUXURY WINDOWS
I T A L I A

Design: Centro Ricerche Fontanot
Design: Fontanot Research Centre

Fontanot S.p.A. Company System
CSQ ISO-9001 certified

