

PEDESTAL PRIME®

CATALOGO
CATALOGUE

2021
ITA / EN



eternoivica

Abbiamo reinventato il
supporto per pavimentazioni
sopraelevate esterne.

Nasce PEDESTAL PRIME®.

We have reinvented the support for
external raised floors.

PEDESTAL PRIME® is born.

INDICE

INDEX

VANTAGGI DEL SOPRAELEVATO ADVANTAGES OF THE RAISED FLOOR	4
--	----------

SUPPORTI PEDESTAL PRIME® PEDESTAL PRIME® SUPPORTS	6
---	----------

Introduzione al prodotto

Product introduction

Caratteristiche di Pedestal Prime®

Features of Pedestal Prime

Descrizione componenti

Components description

L'innovazione parte dalla base

Innovation starts from the base

Prolunga integrata

Integrated extension

Prolunga per grandi altezze

Extension for great heights

Accessorio per avvitatore

Accessory for screwdriver

Testa XL

XL head

PEDESTAL PRIME® SOTTOSTRUTTURA CON TRAVETTO PEDESTAL PRIME® SUBSTRUCTURE WITH JOIST	20
---	-----------

Sottostruttura con Pedestal Prime® per travetto in alluminio

Substructure with Pedestal Prime for aluminium joist

Accessori per travetti

Accessories for joists

Sottostruttura con Pedestal Prime® per travetto in legno

Substructure with Pedestal Prime for wooden joist

ACCESSORI ACCESSORIES	32
---------------------------------	-----------

Panoramica completa degli accessori Pedestal

Complete overview of Pedestal accessories

VANTAGGI DEL SOPRAELEVATO

ADVANTAGES OF THE RAISED



Ottimo nascondiglio per tubi ed impianti

L'intercapedine tra pavimentazione e membrana sottostante, permette il passaggio di tubi ed impianti che vengono così mascherati rimanendo tuttavia facilmente ispezionabili.

Excellent hiding place for pipes and systems

The interspace between the floor and the underlying membrane allows the passage of pipes and systems that are thus masked but still easy to inspect.



Significativa diminuzione del peso

Con l'eliminazione del massetto di calcestruzzo, il sistema sopraelevato consente una diminuzione sostanziale del peso che grava sulla struttura ed una reale diminuzione dei costi.

Significant weight reduction

With the elimination of the concrete screed, the raised system allows a substantial reduction of the weight on the structure and a real reduction in costs.



Pavimento sempre piano e facilmente ispezionabile

Il sistema permette di compensare i piccoli dislivelli e le pendenze del piano di posa. In caso di posa su membrana impermeabilizzante, questa è facilmente ispezionabile data l'assenza di fissaggi meccanici fra il rivestimento e i supporti.

Floor always leveled and easily inspectable

The Pedestal system makes it possible to compensate for the small differences in height and slope of the laying surface. In case of laying on waterproofing membrane, this can be easily inspected due to the absence of mechanical fixings between the covering and the supports.

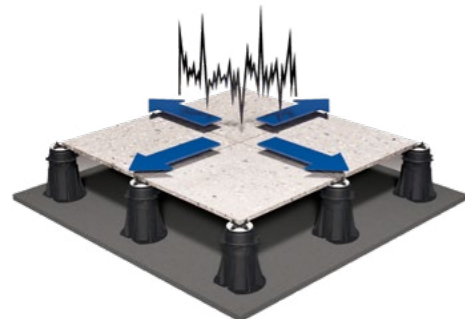

Ottimo assorbimento delle dilatazioni

L'indipendenza della pavimentazione e dei supporti di sostegno consente di assorbire le dilatazioni ed i movimenti strutturali.

Excellent absorption of expansions

The independence of the flooring and of the supports allows to absorb expansions and the structural movements.



Velocità di posa in opera

La velocità di posa assicura notevoli vantaggi nella gestione del cantiere generando un risparmio economico; nel caso di ristrutturazioni il tempo di intervento limitato riduce i disagi per gli abitanti.

Speed of installation

The speed of laying ensures considerable advantages in the management of the building site generating an economic saving; in the case of renovations, the limited intervention time reduces the inconvenience for the inhabitants.



Rapido deflusso dell'acqua

La fuga tra una piastra e l'altra consente il rapido deflusso dell'acqua che viene convogliata tramite la pendenza sottostante.

Rapid water outflow

The small escape between one plate and the other allows the rapid flow of water that is conveyed through the slope below.

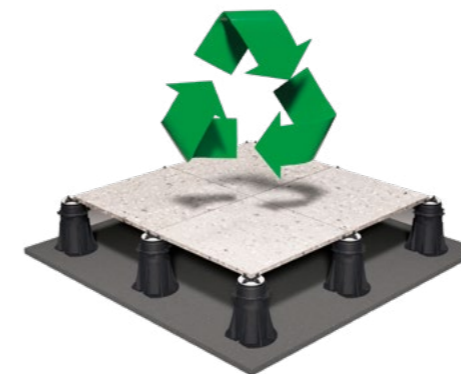

Ecologia e pulizia

Tutto è riciclabile, sia gli elementi di pavimentazione che la sottostruttura di supporto. A fine vita dell'edificio e/o del pavimento, tutto potrà essere agevolmente rimosso e riciclato senza impatto sull'ambiente. Il sistema di posa "a secco" non prevede collanti o prodotti chimici.

Ecology and cleanliness

Everything is recyclable, both the flooring elements and the substructure. At the end of the life of the building and / or floor, everything can be easily removed and recycled without impact on the environment. The "dry" laying system does not require adhesives or chemical products.



Forte resistenza ai pesi

La robusta struttura del supporto conferita non solo dall'esperienza nel formulare il compound ma anche dalla filettatura continua tra base e vite, garantisce un prodotto forte, sicuro e duraturo.

Strong weight resistance

The sturdy structure of the support given not only by the experience in formulating the compound but also by the continuous threading between base and screw, guarantees a strong, safe and long lasting product.



Migliore isolamento acustico

Grazie alla testa "bi-component" anti scivolamento e antirumore, i supporti Prime sono in grado di abbattere il livello sonoro fino a 25 dB.

Better sound insulation

Thanks to the "anti-slip and anti-noise" bi-component "head, Prime supports are able to reduce the sound level up to 25 dB.

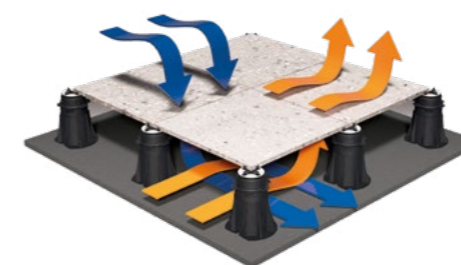

Migliore isolamento termico

L'intercapedine fra pavimentazione e membrana sottostante favorisce un costante passaggio d'aria con maggior durata dell'impermeabilizzazione.

Better thermal insulation

The interspace between flooring and underlying membrane favors a constant air passage with a longer duration of waterproofing and thermal insulation.

PEDESTAL PRIME®

Mentre il mondo copia le nostre idee e i nostri modelli ci siamo spinti oltre, abbiamo osato, con l'entusiasmo e la passione che ci contraddistinguono. Abbiamo creato un prodotto sorprendente, abbiamo reinventato il supporto per le pavimentazioni esterne. Siamo orgogliosi, abbiamo realizzato un capolavoro di ingegneria, unico, complesso da progettare ma semplice da utilizzare, con più elementi che si integrano tra di loro in un unico assieme perfetto. Un prodotto straordinario, frutto di un'esperienza di 65 anni e di un grande lavoro di squadra, solo con tanta passione e professionalità potevamo progettare un prodotto simile, semplice, forte e bello.

Semplice, perchè già assemblato e pronto per la posa.

Forte, perchè resistente a carichi eccezionali, oltre ogni normativa.

Bello, perchè anche il design è stato curato nei minimi dettagli.

While the world copies our ideas and our models we have gone further, we have dared, with the enthusiasm and passion that distinguishes us. We have created an amazing product, we have reinvented the support for external flooring.

We are proud, we have created an engineering masterpiece, unique, complex to design but simple to use, with multiple elements that integrate with each other in a single perfect assembly.

An extraordinary product, the result of 65 years of experience and great teamwork, only with such passion and professionalism could we design a similar, simple, strong and beautiful product.

Simple, because already assembled and ready for installation.

Strong, because resistant to exceptional loads, beyond all regulations.

Beautiful, because even the design has been studied in detail.



CARATTERISTICHE PEDESTAL PRIME®

PEDESTAL PRIME® FEATURES



Da 30 mm a 420 mm di altezza con solo tre prodotti
From 30 mm to 420 mm in height with only three products



Un unico prodotto con tutti gli elementi integrati
A single product with all the integrated elements



Base con deflusso acqua sicuro e garantito
Base with safe and guaranteed water flow



Testa rivestita con 2 mm di gomma antirumore e antiscivolo
Head coated with 2 mm of anti-noise and anti-slip rubber



Riduzione dello spazio in magazzino
Reduction of warehouse space



Base piena da 300 cm² con sagoma speciale brevettata
300 cm² solid base with patented special shape



Chiave per regolazione altezza
Height adjustment wrench



Alette facilmente asportabili
Easily removable tabs



Testa autolivellante per pendenze da 0 a 5%
Self-leveling head for slopes from 0 to 5%



Base con "asole" per aggancio "clip" veloce brevettata
Base with "slots" for fast "clip" attachment patented



Blocchi di sicurezza antisvitamento
Anti-unscrewing safety blocks



Alette con spessore 2-3-4-5-6-7-8-9-10 mm
Tabs with thickness 2-3-4-5-6-7-8-9-10 mm



Un solo taglio della base per fare l'angolo
A single cut of the base to make the corner



Un unico prodotto autolivellante o fisso, grazie all'inserimento del "blocco testa"
A single self-leveling or fixed product, thanks to the insertion of the "head block"



Non servono anelli, tubi o prolunghe aggiuntive, la prolunga è integrata ed ergonomica
No additional rings, tubes or extensions are needed, the extension is integrated and ergonomic

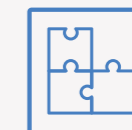

Compatibile con tutti gli accessori della gamma PEDESTAL-WOODECK
Compatible with all accessories of the PEDESTAL-WOODECK range



Spese di trasporto considerevolmente ridotte dato che il prodotto viene fornito assemblato
Transport costs considerably reduced as the product is supplied assembled

DESCRIZIONE COMPONENTI

COMPONENTS DESCRIPTION



Blocco testa basculante
Locking system for self leveling pedestal

Testa autolivellante Ø 110 mm con gomma antirumore
Self-leveling head Ø 110 mm with anti-noise and anti-slip rubber

Vite
Screw

Prolunga integrata
Integrated extension

Base
Base

teste speciali

optional heads



Testa XL Ø 150 mm
XL head Ø 150 mm



Testa universale per travetto in legno
Universal head for wooden joist



Testa per travetto in alluminio
Head for aluminium joist



Testa a incrocio per travetti in alluminio
Crisscross head for aluminium joists

L'INNOVAZIONE PARTE DALLA BASE

INNOVATION STARTS FROM THE BASE

La base di Pedestal Prime® lo rende un prodotto rivoluzionario nel campo dei supporti per pavimentazioni sopraelevate. La speciale sagoma BREVETTATA consente un notevole risparmio in fase di posa.

The base of Pedestal Prime® makes it a revolutionary product in the field of supports for raised floors. The special PATENTED shape allows a considerable saving in the laying phase.

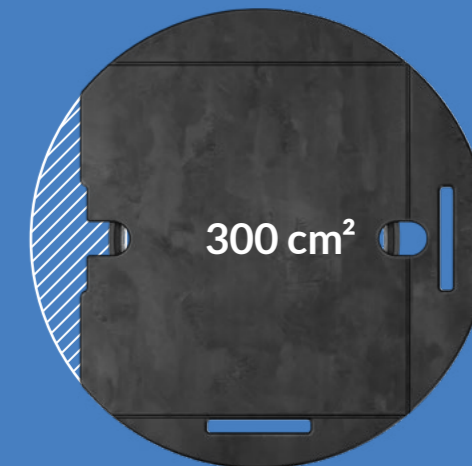

Basta un solo taglio seguendo la preincisione sul fondo per convertirla in una base per angolo. La base di Pedestal Prime® è stata progettata per garantire il deflusso dell'acqua in modo sicuro e ottimale.

A single cut is enough following the pre-engraving on the bottom to convert it into a base per corner. The Pedestal Prime® base has been designed to ensure the flow of water in a safe and optimal way.

Per facilitare e velocizzare ulteriormente la fase di posa sono state predisposte due "asole" per l'aggancio delle clip, assicurando così una presa ottimale al supporto. (BREVETTATO)

To further facilitate and speed up the installation phase, two "slots" have been prepared for attaching the clips, thus ensuring optimal grip to the support. (PATENTED)

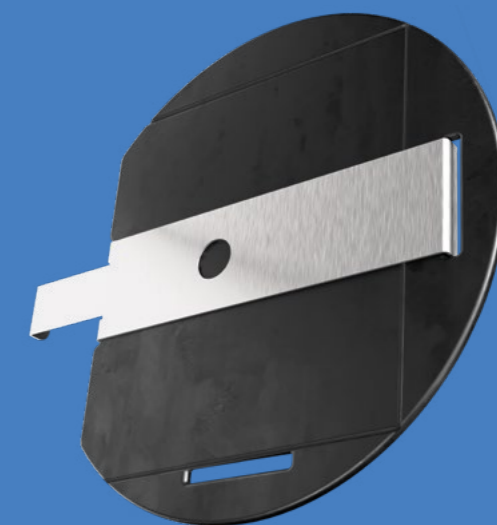

PROLUNGA INTEGRATA

INTEGRATED EXTENSION

Con i supporti Pedestal Prime® non servono anelli, tubi o prolunghes aggiuntive: la prolunga è già integrata. Tre diverse misure per adattarsi perfettamente alle tre basi e consentire di coprire tutte le altezze da 30 mm a 420 mm. La sua forma ergonomica inoltre ne facilita la regolazione.

With the Pedestal Prime® supports you do not need additional rings, tubes or extensions: the extension is already integrated. Three different sizes to adapt perfectly to the three bases and allow you to cover all heights from 30 mm to 420 mm. Its ergonomic shape also makes it easy to adjust.

PR1 e PR3 con testa Ø110; distanziatore perimetrale; clip tamponamento verticale base; profilo bordo piastra.
PR1 and PR3 with Ø110 head; perimeter spacer; base vertical infill clip; plate edge profile.



420 mm

155 mm

30 mm

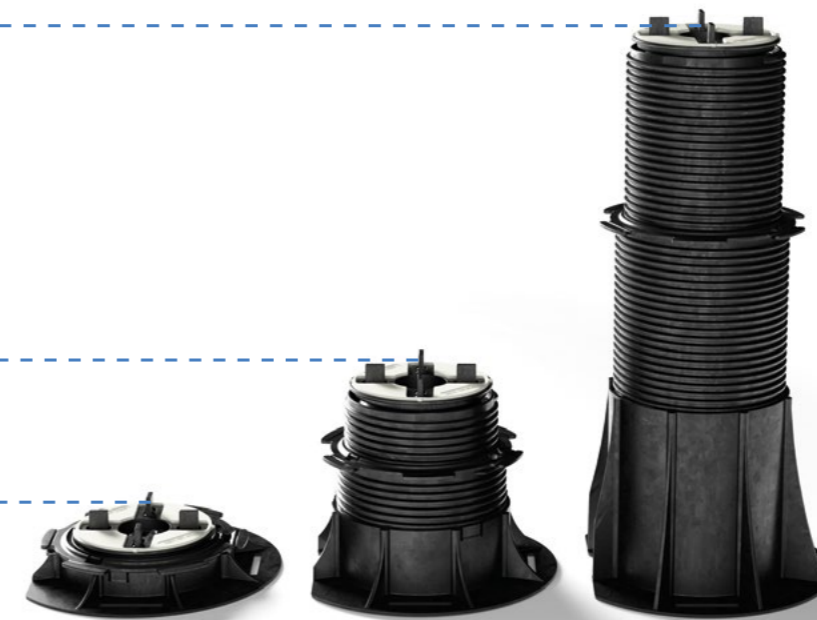

3 modelli di Pedestal Prime®

PR1: da 30 a 65 mm
PR2: da 65 a 155 mm
PR3: da 155 a 420 mm

3 Pedestal Prime models®

PR1: from 30 to 65 mm
PR2: from 65 to 155 mm
PR3: from 155 to 420 mm



PROLUNGA PER GRANDI ALTEZZE

EXTENSION FOR GREAT HEIGHTS

Nel caso di altezze superiori a 420 mm Eterno Ivica ha progettato **la Prolunga per grandi altezze**, un elemento che si inserisce facilmente tra la "prolunga integrata" e la vite, adattabile al supporto PR3. Una, due o tre prolunghe, per raggiungere le altezze di 595 mm, 770 mm e 945 mm. Anche questo elemento è dotato del blocco di sicurezza, sia nella parte inferiore che in quella superiore, in totale sicurezza sempre con la garanzia Pedestal by Eterno Ivica.

*In the case of heights greater than 420 mm Eterno Ivica has designed **the Extension for great heights**, an element that fits easily between the "integrated extension" and the screw, adaptable to the PR3 support. One, two or three extensions, to reach heights of 595 mm, 770 mm and 945 mm. This element is also equipped with a safety lock, both in the lower and in the upper part, in total safety always with the Pedestal guarantee by Eterno Ivica.*



PR3 con testa Ø110 ; PR3 + 2 prolunghe con testa Ø110;
clip tamponamento verticale testa; clip tamponamento
verticale base; distanziatore perimetrale.
PR3 with head Ø110; PR3 + 2 extensions with head Ø110;
vertical head plugging clip; base vertical infill clip;
perimeter spacer.



PR1 e PR3 con testa Ø110; clip tamponamento verticale testa; clip tamponamento verticale base; distanziatore perimetrale. PR1 and PR3 with Ø110 head; vertical head plugging clip; base vertical infill clip; perimeter spacer.

Grazie alla testa autolivellante il supporto PRIME si adatta alla superficie di appoggio e compensa pendenze fino al 5%, permettendo di avere una pavimentazione perfettamente piana anche su terreno non regolare.

Thanks to the self-leveling head, the PRIME support adapts to the surface and compensates for slopes up to 5%, allowing to have a perfectly flat pavement even on rough ground.



DETTAGLIO TAMPONAMENTO DEL BORDO

Le clip per tamponamento verticale costituiscono un innovativo sistema che permette di chiudere facilmente ed elegantemente lo spazio perimetrale che si crea in presenza di pavimentazioni sopraelevate. Una soluzione composta di due particolari clip in acciaio inox che, messe sopra la testa e sotto la base del supporto Eterno Ivica, creano una sede con dei mordenti che incastrano la porzione di pavimentazione rifilata a misura dello spazio da tamponare, evitando in modo contestuale lo scivolamento delle piastre orizzontali grazie al blocco posto all'estremità della clip. Grazie a questo sistema è possibile realizzare anche dei gradini.

CLIP FOR VERTICAL CLOSURE DETAIL

This solution represents an innovative, easy and elegant way to eliminate gaps around raised floors. The system consists of two special, stainless steel clips for positioning over the head and under the base of the Eterno Ivica support. It creates a firm seat capable of gripping the section of floor cut to size to fill the gap. The use of our floor edge clip effectively prevents horizontal movement in floor slabs. Thanks to this system it is also possible to create steps.





Dettaglio del nuovo accessorio per avvitatore in acciaio per lo "svitamento e avvitemento rapido".

Detail of the steel screwdriver accessory for "quick unscrewing and screwing".

PR2 con testa Ø150; distanziatore perimetrale in acciaio inox.
PR2 with head Ø150; perimeter spacer in stainless steel.

Dettaglio testa XL Ø150 che garantisce maggiore stabilità grazie alla maggior superficie di appoggio.

Detail of the head XL Ø150 which guarantees greater stability thanks to the larger support surface.



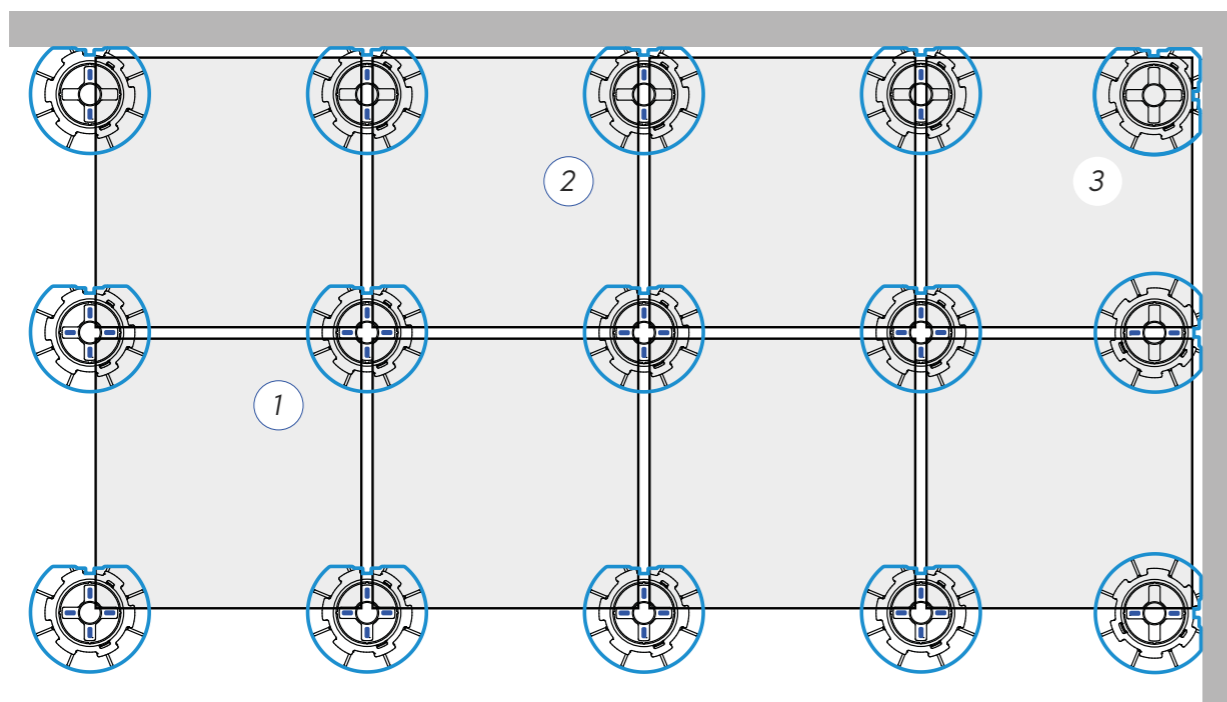

- 1  centro pavimento
in the middle
- 2  bordo muro
along the wall
- 3  angolo muro
at the corner

ESEMPI DI APPLICAZIONE

La posa del sistema sopraelevato non è mai stata così semplice. Anche i supporti Pedestal PRIME®, infatti, non hanno bisogno di accessori o elementi aggiuntivi per essere posati: basta rompere le alette pretagliate per adattare la testa alle diverse necessità applicative. Centro pavimento; bordo muro e angolo muro. A lato lo schema rappresentativo.

APPLICATION EXAMPLES

The installation of the raised system has never been easier. In fact, even the Pedestal PRIME® supports do not need accessories or additional elements to be installed: just break the pre-cut flaps to adapt the head to the different application needs. Center floor; wall edge and wall corner. On the side the representative scheme.

PR1 con testa Ø110; distanziatore perimetrale in PP.
PR1 with head Ø110; perimeter spacer in PP.



PEDESTAL PRIME® PER TRAVETTO IN ALLUMINIO

PRIME PEDESTAL® FOR ALUMINIUM JOIST

Il supporto regolabile PRIME con testa per travetto in alluminio è la soluzione più flessibile, elegante e sicura mai vista per terrazzi, decking e bordi piscina. Le prestazioni di livellamento della testa basculante, che compensa pendenze del massetto fino al 5%, permette di ottenere una pavimentazione sempre perfettamente piana senza ricorrere ad ulteriori accorgimenti o accessori.

The PRIME adjustable support with aluminium joist head is the most flexible, elegant and safe solution ever seen for terraces, decking and pool edges. The leveling performance of the tilting head, which cancels the screed slopes up to 5% allows to obtain a perfectly leveled floor, without resorting to additional features or accessories.

ACCESSORI PER TRAVETTI ALLUMINIO

ACCESSORIES FOR ALUMINIUM JOISTS

1. clip laterale 90°
side clip 90°
2. clip distanziale 90°
spacer clip 90°
3. clip distanziale 110°
spacer clip 110°
4. giunto travetti in alluminio
joint aluminium joists
5. gomma antirumore
anti-noise rubber
6. distanziatore con alette per piastre in gres porcellanato da 2/3/4 mm
spacer 2/3/4 mm with flaps for porcelain stoneware plates

7. clip tamponamento verticale testa, per decking con travetto alluminio
vertical closure head clip, for decking with aluminium joist
8. clip tamponamento verticale base, per decking con travetto alluminio
vertical closure base clip, per decking with aluminium joist
9. clip tamponamento verticale testa Ø150 mm, 20/30/40 mm
vertical closure head clip Ø150 mm, 20/30/40 mm
10. clip tamponamento verticale base Ø110 mm, 20/30/40 mm
vertical closure base clip Ø110 mm, 20/30/40 mm
11. guarnizione in pvc per travetto a deflusso rapido
PVC gasket for quick flow joist
12. travetto in alluminio
aluminium joists
13. travetto in alluminio a binario per deflusso rapido
aluminium rail joist for rapid flow

Il tamponamento del bordo della pavimentazione è un dettaglio che non può essere lasciato al caso. La clip WFS® per tamponamento verticale permette di chiudere con estrema facilità e massima eleganza i bordi perimetrali delle pavimentazioni sopraelevate. Questa soluzione è composta da due particolari clip in acciaio inox, conformate in modo da accoppiarsi perfettamente con il travetto in alluminio e sotto la base del supporto Eterno Ivica. In questo modo si crea l'aggancio per il travetto di chiusura laterale a cui si fisserà infine il listone di tamponamento opportunamente dimensionato.

The infill of the pavement edge is a detail that can not be left to chance. The WFS® vertical padding clip makes it possible to close the perimeter edges of raised floors with extreme ease and elegance. This solution is composed of two special clips in stainless steel, shaped as to be perfectly coupled with the aluminium joist and under the base of the Eterno Ivica support. In this way the hooking is created for the lateral closing joist to which the suitably dimensioned padded board is finally positioned.

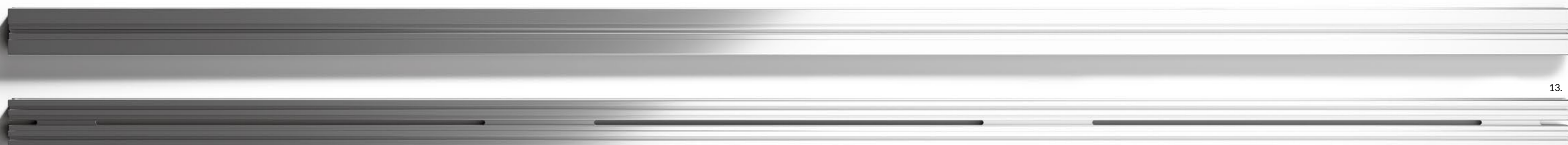
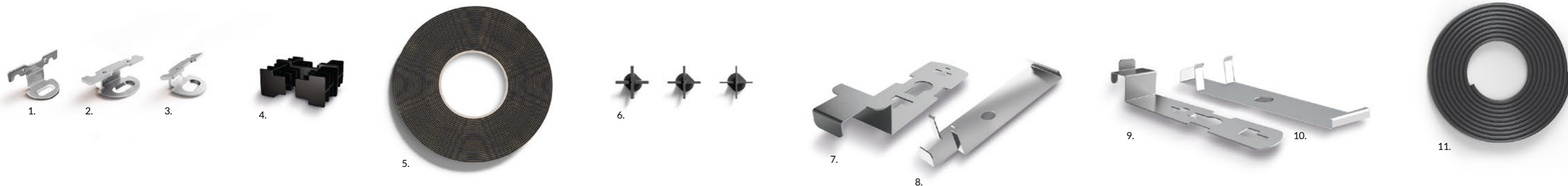



PR2 con testa per travetto Ø110; clip distanziale 90° in acciaio inox.
PR2 with head for Ø110 joist; spacer clip 90° in stainless steel.



Grazie alla testa autolivellante il supporto PRIME si adatta alla superficie di appoggio e compensa pendenze fino al 5%, permettendo di avere una pavimentazione perfettamente piana anche su terreno non regolare.

Thanks to the self-leveling head, the PRIME support adapts to the surface and compensates for slopes up to 5%, allowing to have a perfectly flat pavement even on rough ground.



0-5%

Dettaglio compensazione pendenza con utilizzo di sistema travetto per posa di piastre ceramiche.

Slope compensation detail using the joist system for laying ceramic plates.

PR3 con testa per travetto incrocio Ø130; distanziatore per travetto alluminio; travetto a binario per deflusso rapido con profilo in gomma.
PR3 with head for Ø130 cross beam; spacer for aluminium joists; rail joist for rapid flow with rubber profile.



Dettaglio travetto alluminio a binario per deflusso rapido con profilo in gomma.

Detail of rail aluminium joist for rapid flow with rubber profile.

PEDESTAL PRIME® PER TRAVETTO IN LEGNO

PRIME PEDESTAL® FOR WOODEN JOIST

Il supporto regolabile PRIME con testa per travetto in legno è la soluzione più flessibile, elegante e sicura mai vista per terrazzi, decking e bordi piscina. Le prestazioni di livellamento della testa basculante, che compensa pendenze del massetto fino al 5%, permette di ottenere una pavimentazione sempre perfettamente piana senza ricorrere ad ulteriori accorgimenti o accessori.

The PRIME adjustable support with wooden joist head is the most flexible, elegant and safe solution ever seen for terraces, decking and pool edges. The leveling performance of the tilting head, which cancels the screed slopes up to 5% allows to obtain a perfectly leveled floor, without resorting to additional features or accessories.

PR1 con testa per travetto legno.
PR1 with head for wooden joist.



L'aletta, presente nella testa del supporto, riporta un'incisione orizzontale che facilita l'asportazione della parte superiore per accogliere travetti di basso spessore.

The tab, present in the head of the support, presents a horizontal incision that facilitates the removal of the upper part for accommodating low thickness joists.



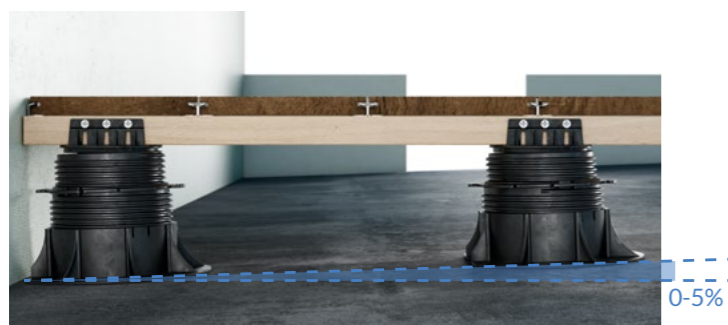

Dettaglio compensazione pendenza con utilizzo di Pedestal Prime® con travetto in legno per posa di listoni in legno.

Slope compensation detail using Pedestal Prime with wooden joist for laying wooden planks.

PR3 con testa per travetto in legno.
PR3 with head for wooden joist.

SUPPORTI

SUPPORTS

PEDESTAL PRIME®	BASE + VITE + PROLUNGA INTEGRATA BASE + SCREW + INTEGRATED EXTENSION	DESCRIZIONE DESCRIPTION	MISURA SIZE	UNIT 	UNIT 
	E502030065	PR1	30-65 mm	25	1.350
	E502060155	PR2	65-155 mm	25	750
	E502150420	PR3	155-420 mm	12	360

Le misure indicate si riferiscono a BASE + VITE + PROLUNGA INTEGRATA + TESTA Ø110 mm autolivellante bicomponente.
The measures indicated refer to BASE + SCREW + INTEGRATED EXTENSION + HEAD Ø110 mm two-component self-leveling.

COMPOSIZIONE GRANDI ALTEZZE

GREAT HEIGHTS COMPOSITION

PEDESTAL PRIME®	MISURA SIZE	UNIT 
PR3 + 1 prolunga PPR PR3 + 1 PPR extension	315-595 mm	12 PR3 + 12 PPR
PR3 + 2 prolunghie PPR PR3 + 2 PPR extensions	415-770 mm	12 PR3 + 2 X 12 PPR
PR3 + 3 prolunghie PPR PR3 + 3 PPR extensions	520-945 mm	12 PR3 + 3 X 12 PPR





TESTE E COMPONENTI

HEADS AND COMPONENTS

TESTA HEAD	CODICE CODE	DESCRIZIONE DESCRIPTION	MISURA SIZE	UNIT 	UNIT 
	E035101204	Testa bicomponente autolivellante Two-component self-leveling head	Ø110 mm aletta spessore 4 mm, altezza 12 mm Ø110 mm fin thickness 4 mm, height 12 mm	200	-
	E035201204	Testa XL bicomponente autolivellante* Self-leveling two-component XL head*	Ø150 mm aletta spessore 4 mm, altezza 12 mm Ø150 mm fin thickness 4 mm, height 12 mm	100	-
	E035102530	Testa autolivellante per decking Self-leveling head for decking	Ø110 mm	100	-
	E035100010	Testa bicomponente autolivellante per travetto in alluminio Two-component self-leveling head for aluminium joist	Ø110 mm	200	-
	E035203001	Testa bicomponente autolivellante a incrocio per travetto alluminio Two-component self-leveling cross head for aluminum joist	Ø130 mm	150	4.200

*L'altezza dei supporti PR aumenta di 4 mm.

*With XL head, height of all the PR range increases of 4 mm.

COMPONENTI COMPONENTS	CODICE CODE	DESCRIZIONE DESCRIPTION	MISURA SIZE	UNIT 	UNIT 
	E501000190	Prolunga PPR* PPR extension*	-	12	-
	E036000100	Blocco testa antibasculamento Tilting head block	-	100	-

*Utilizzabile con PR3

*Usable with PR3

ACCESSORI

ACCESSORIES

1. piastra di sicurezza
safety plate
2. accessorio per aumentare lo spessore delle alette
accessory to increase the thickness of the fins
3. chiave di regolazione
adjustment key
4. clip tamponamento verticale testa Ø150
20/30/40 mm
vertical closure clip head Ø150 20/30/40 mm
5. maniglia alza piastra
plate lifting handle
6. clip per piastra esagonali 2/3/4 mm
2/3/4 mm hexagonal plate clips
7. blocco testa basculante
tilting head block
8. clip tamponamento verticale base Ø110
20/30/40 mm
vertical closure clip base Ø110 20/30/40 mm
9. livellatore in gomma LH
LH rubber leveler
10. prolunga per grandi altezze
extension for great heights
11. maniglia posa piastra zincata regolabile
380-620 mm
zinc-plated adjustable lifting handle 380-620 mm
12. maniglia posa piastre zincate fissa
zinc-plated fixed lifting handle
13. livellatori in gomma LGH1 mm, LGH2 mm, LGH3 mm
rubber levelers LGH1 mm, LGH2 mm, LGH3 mm
14. SCUDO - strato separatore
SCUDO - separating layer
15. distanziatore perimetrale in PP
perimeter spacer in PP
16. distanziatore perimetrale in acciaio inox
perimeter spacer in stainless steel
17. accessorio per avvitatore in acciaio per lo "svitamento e avvitamento rapido"
steel screwdriver accessory for "quick unscrewing and screwing"
18. profilo bordo piastra 20 mm
plate edge profile 20 mm

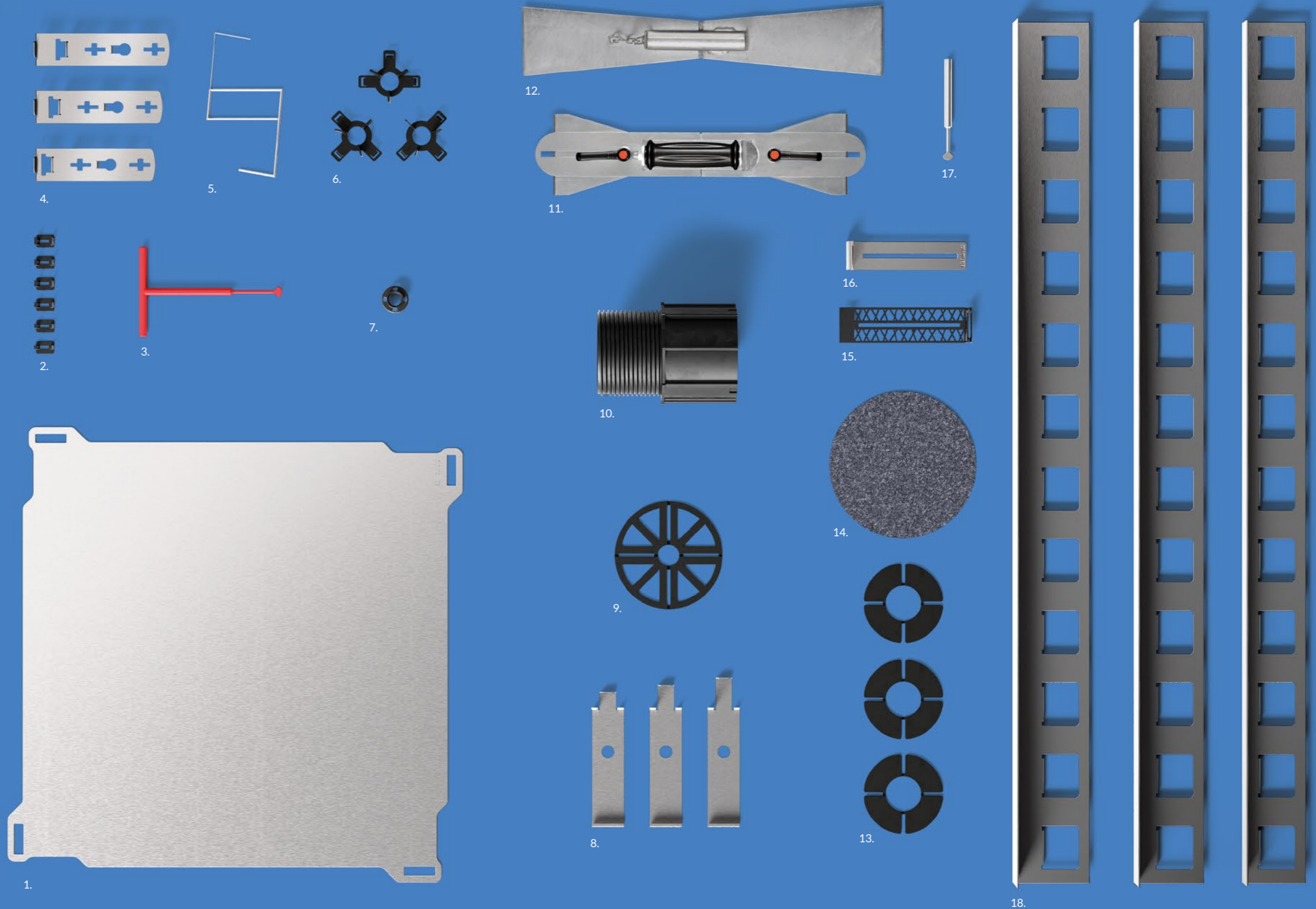



ACCESSORI

ACCESSORIES

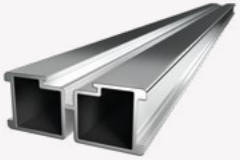

TRAVETTO IN ALLUMINIO

ALUMINIUM JOIST

PRODOTTO PRODUCT	CODICE CODE	DESCRIZIONE DESCRIPTION	MISURA SIZE	UNIT	UNIT
	Q231020025	Travetto alluminio Aluminium joist	60x25 mm L. 2000 mm	-	-
	V13052100	Gomma antirumore Noise insulating rubber	15x2 mm	rotolo da 10 mt roll of 10 mt	-
	Q200000025	Giunto per travetto alluminio Joint for aluminium joists	-	200	-

TRAVETTO IN ALLUMINIO A DEFLUSSO RAPIDO

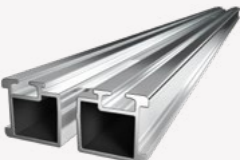
QUICK-FLOW ALUMINIUM JOIST

PRODOTTO PRODUCT	CODICE CODE	DESCRIZIONE DESCRIPTION	MISURA SIZE	UNIT	UNIT
	Q231420026	Travetto alluminio a deflusso rapido Quick flow aluminium joist	60x25 mm L. 2000 mm	-	-
	V13052200	Guarnizione in pvc per travetto a deflusso rapido PVC gasket for quick flow joist	8,4x5,3 mm	rotolo da 200 mt roll of 200 mt	-
	Q200000026	Giunto per travetto a deflusso rapido Quick-flow joist joint	-	200	-

DISTANZIATORE PER TRAVETTO IN ALLUMINIO

SPACER FOR ALUMINIUM JOIST

PRODOTTO PRODUCT	CODICE CODE	DESCRIZIONE DESCRIPTION	MISURA SIZE	UNIT	UNIT
	E004000104	Distanziatore per travetto alluminio - aletta 4 mm H12 mm* Spacer for aluminium joist - 4 mm tabs H12 mm*	-	1.000	-

*Alette distanziatrici spessore 2 o 3 mm disponibili su richiesta

*Spreader tabs 2 or 3 mm thick available on request.

CLIP LATERALE A 90° PER TRAVETTO IN ALLUMINIO

90 ° SIDE CLIP FOR ALUMINIUM JOISTS

PRODOTTO PRODUCT	CODICE CODE	DESCRIZIONE DESCRIPTION	MISURA SIZE	UNIT	UNIT
	Q200000240	Clip laterale a 90° per travetto in alluminio* 90 ° side clip for aluminium joists*	90°	1	-

*Comprende vite autofilettante

*Includes self-tapping screw

CLIP DISTANZIALE PER DECKING PER TRAVETTO IN ALLUMINIO



SPACER CLIP FOR DECKING FOR ALUMINIUM JOIST

PRODOTTO PRODUCT	CODICE CODE	DESCRIZIONE DESCRIPTION	MISURA SIZE	UNIT	UNIT
	Q200000231	Clip 110° per decking per travetto in alluminio 110 ° spacer clip for decking on aluminium joist	110°	50	-
	Q200000232	Clip 90° per decking per travetto in alluminio 90 ° spacer clip for decking on aluminium joist	90°	50	-

SCUDO STRATO SEPARATORE SCUDO-SEPARATING LAYER

PRODOTTO PRODUCT	CODICE CODE	DESCRIZIONE DESCRIPTION	MISURA SIZE	UNIT	UNIT
	E083000233	Scudo strato separatore adesivo - spessore 3 mm <i>Adhesive separating layer shield - 3 mm thick</i>	Ø205 mm	1	-
	E083000223	Scudo strato separatore non adesivo - spessore 3 mm <i>Non-adhesive separating layer shield - 3 mm thick</i>	Ø205 mm	1	-



LIVELLATORE IN GOMMA RUBBER LEVELER

PRODOTTO PRODUCT	CODICE CODE	DESCRIZIONE DESCRIPTION	MISURA SIZE	UNIT	UNIT
	E081003000	Livellatore in gomma LH3 <i>Rubber leveler LH3</i>	Ø150 mm h 3 mm	250	-
	E082001000	Livellatore in gomma LGH1 <i>Rubber leveler LGH1</i>	Ø110 mm h 1 mm	800	-
	E082002000	Livellatore in gomma LGH2 <i>Rubber leveler LGH2</i>	Ø110 mm h 2 mm	600	-
	E082003000	Livellatore in gomma LGH3 <i>Rubber leveler LGH3</i>	Ø110 mm h 3 mm	500	-

PROFILO BORDO PIASTRA PLATE EDGE PROFILE

PRODOTTO PRODUCT	CODICE CODE	DESCRIZIONE DESCRIPTION	MISURA SIZE	UNIT	UNIT
	P021200020	Profilo bordo piastra Inox <i>Stainless steel plate edge profile</i>	20 mm L. 1200 mm	1	-
	P021200120	Profilo bordo piastra alluminio <i>Aluminium plate edge profile</i>	20 mm L. 1200 mm	1	-
	P021200220	Profilo bordo piastra alluminio RAL 7043 <i>Aluminium plate edge profile RAL 7043</i>	20 mm L. 1200 mm	1	-

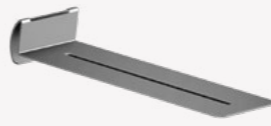
DISTANZIATORE PERIMETRALE PERIMETER SPACER

PRODOTTO PRODUCT	CODICE CODE	DESCRIZIONE DESCRIPTION	MISURA SIZE	UNIT	UNIT
	P021000220	Distanziatore perimetrale acciaio Inox <i>Stainless steel perimeter spacer</i>	-	100	-
	P021000230	Distanziatore perimetrale in Polipropilene <i>Perimeter spacer in Polypropylene</i>	-	200	-



CHIAVE DI REGOLAZIONE E ACCESSORIO PER AVVITATORE ADJUSTMENT KEY AND SCREWDRIVER ACCESSORY

PRODOTTO PRODUCT	CODICE CODE	DESCRIZIONE DESCRIPTION	MISURA SIZE	UNIT	UNIT
	E200250120	Chiave di regolazione <i>Adjustment Key</i>	-	1	-
	E200250130	Accessorio per avvitatore <i>Screwdriver accessory</i>	-	1	-

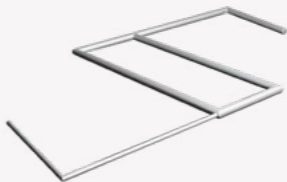
MANIGLIA ALZA PIASTRA IN ACCIAIO INOX PLATE LIFTING HANDLE IN STAINLESS STEEL

PRODOTTO PRODUCT	CODICE CODE	DESCRIZIONE DESCRIPTION	MISURA SIZE	UNIT	UNIT
	M030000100	Alza piastra in acciaio inox <i>Plate lifting handle in stainless steel</i>	-	1	-

ACCESSORIO PER AUMENTARE LO SPESSORE DELLE ALETTE ACCESSORY TO INCREASE THE THICKNESS OF THE FINS

PRODOTTO PRODUCT	CODICE CODE	DESCRIZIONE DESCRIPTION	MISURA SIZE	UNIT 	UNIT 
	E004000305	Accessorio per aumentare lo spessore delle alette Accessory to increase the thickness of the fins	Spessore 5 mm Thickness 5 mm	2.500	-
	E004000306	Accessorio per aumentare lo spessore delle alette Accessory to increase the thickness of the fins	Spessore 6 mm Thickness 6 mm	2.500	-
	E004000307	Accessorio per aumentare lo spessore delle alette Accessory to increase the thickness of the fins	Spessore 7 mm Thickness 7 mm	2.500	-
	E004000308	Accessorio per aumentare lo spessore delle alette Accessory to increase the thickness of the fins	Spessore 8 mm Thickness 8 mm	2.500	-
	E004000309	Accessorio per aumentare lo spessore delle alette Accessory to increase the thickness of the fins	Spessore 9 mm Thickness 9 mm	2.500	-
	E004000310	Accessorio per aumentare lo spessore delle alette Accessory to increase the thickness of the fins	Spessore 10 mm Thickness 10 mm	2.500	-

MANIGLIA POSA PIASTRA ZINCATA GALVANIZED PLATE INSTALLATION HANDLE

PRODOTTO PRODUCT	CODICE CODE	DESCRIZIONE DESCRIPTION	MISURA SIZE	UNIT 	UNIT 
	M030004060	Maniglia posa piastra zincata regolabile Zinc-plated adjustable lifting handle	da 380 a 620 mm from 380 to 620 mm	1	-
	M030400400	Maniglia posa piastra zincata Zinc-plated fixed lifting handle	400 mm	1	-
	M030500500	Maniglia posa piastra zincata Zinc-plated fixed lifting handle	500 mm	1	-
	M030600600	Maniglia posa piastra zincata Zinc-plated fixed lifting handle	600 mm	1	-

PIASTRA DI SICUREZZA SAFETY PLATE



PRODOTTO PRODUCT	CODICE CODE	DESCRIZIONE DESCRIPTION	MISURA SIZE	UNIT 	UNIT 
	P021100060	Piastra di sicurezza Safety plate	600x600 mm h 2 mm	1	-

CLIP PER TAMPONAMENTO VERTICALE VERTICAL CLOSURE CLIP

PRODOTTO PRODUCT	CODICE CODE	DESCRIZIONE DESCRIPTION	MISURA SIZE	UNIT 	UNIT 
	P021000458	Clip per tamponamento verticale testa Vertical closure head clip	Ø150-20 mm	100	-
	P021000322	Clip per tamponamento verticale base Vertical closure base clip	Ø110-20 mm	100	-
	P021000459	Clip per tamponamento verticale testa Vertical closure head clip	Ø150-30 mm	100	-
	P021000323	Clip per tamponamento verticale base Vertical closure base clip	Ø110-30 mm	100	-
	P021000460	Clip per tamponamento verticale testa Vertical closure head clip	Ø150-40 mm	100	-
	P021000324	Clip per tamponamento verticale base Vertical closure base clip	Ø110-40 mm	100	-

CLIP TAMPONAMENTO VERTICALE PER POSA PIASTRE CON TRAVETTO IN ALLUMINIO

VERTICAL INFILL CLIP FOR LAYING PLATES WITH ALUMINIUM JOIST

PRODOTTO PRODUCT	CODICE CODE	DESCRIZIONE DESCRIPTION	MISURA SIZE	UNIT 	UNIT 
	P021000822	Clip per tamponamento verticale testa <i>Vertical closure head clip</i>	Ø150-20 mm	100	-
	P021000322	Clip per tamponamento verticale base <i>Vertical closure base clip</i>	Ø110-20 mm	100	-
	P021000823	Clip per tamponamento verticale testa <i>Vertical closure head clip</i>	Ø150-30 mm	100	-
	P021000323	Clip per tamponamento verticale base <i>Vertical closure base clip</i>	Ø110-30 mm	100	-
	P021000824	Clip per tamponamento verticale testa <i>Vertical closure head clip</i>	Ø150-40 mm	100	-
	P021000324	Clip per tamponamento verticale base <i>Vertical closure base clip</i>	Ø110-40 mm	100	-

CLIP TAMPONAMENTO VERTICALE PER DECKING

VERTICAL INFILL CLIP FOR DECKING

PRODOTTO PRODUCT	CODICE CODE	DESCRIZIONE DESCRIPTION	MISURA SIZE	UNIT 	UNIT 
	P021000432	Clip per tamponamento verticale testa <i>Vertical closure head clip</i>	Ø150-25 mm	100	-
	P021000322	Clip per tamponamento verticale base <i>Vertical closure base clip</i>	Ø110-20 mm	100	-

eternoivica

Art direction:
Accent Barbiero - PD

Images and communication design:
Accent Barbiero - PD

Tutti i diritti sono riservati. Nessuna parte di questa brochure può essere riprodotta in qualunque forma senza autorizzazione di Eterno Ivica s.r.l.

All right reserved. No part of this publication may be reproduced in any form without prior permission from Eterno Ivica s.r.l.

ETERNO IVICA SRL

Via Austria, 25/E
35127
Padova - Italy

T. ITA +39 0498530101
T. EXP +39 0498530102
FAX +39 0498530111

www.eternoivica.com
eternoivica@eternoivica.com



MADE IN ITALY

www.eternoivica.com

