

EUROCASSONETTO SOVRAPPOSTO DOPPIO

versione intonaco

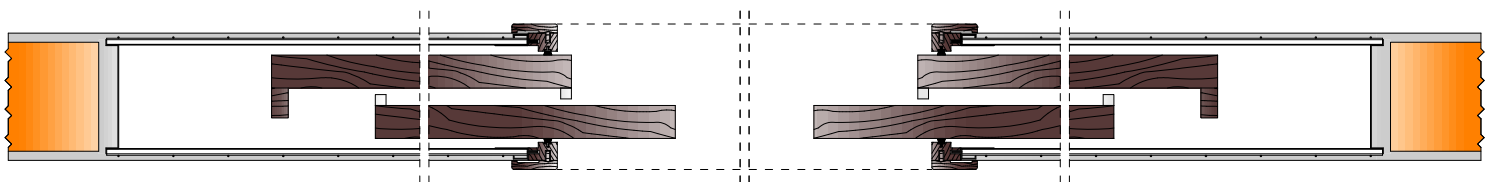

SEZIONE ORIZZONTALE

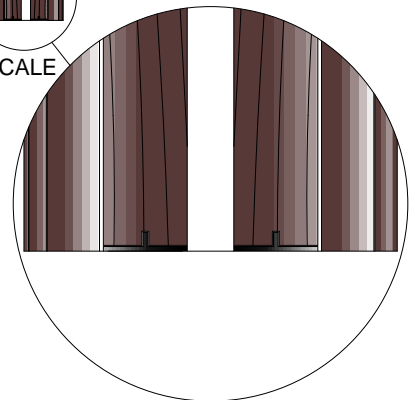
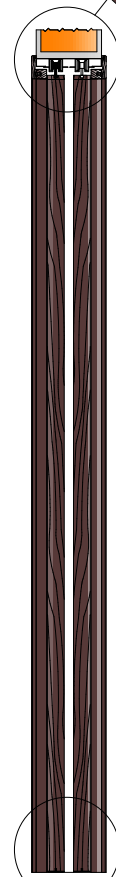
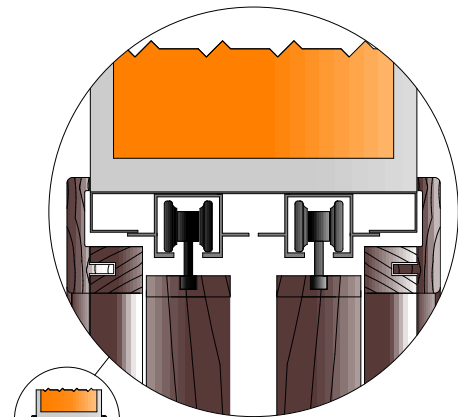
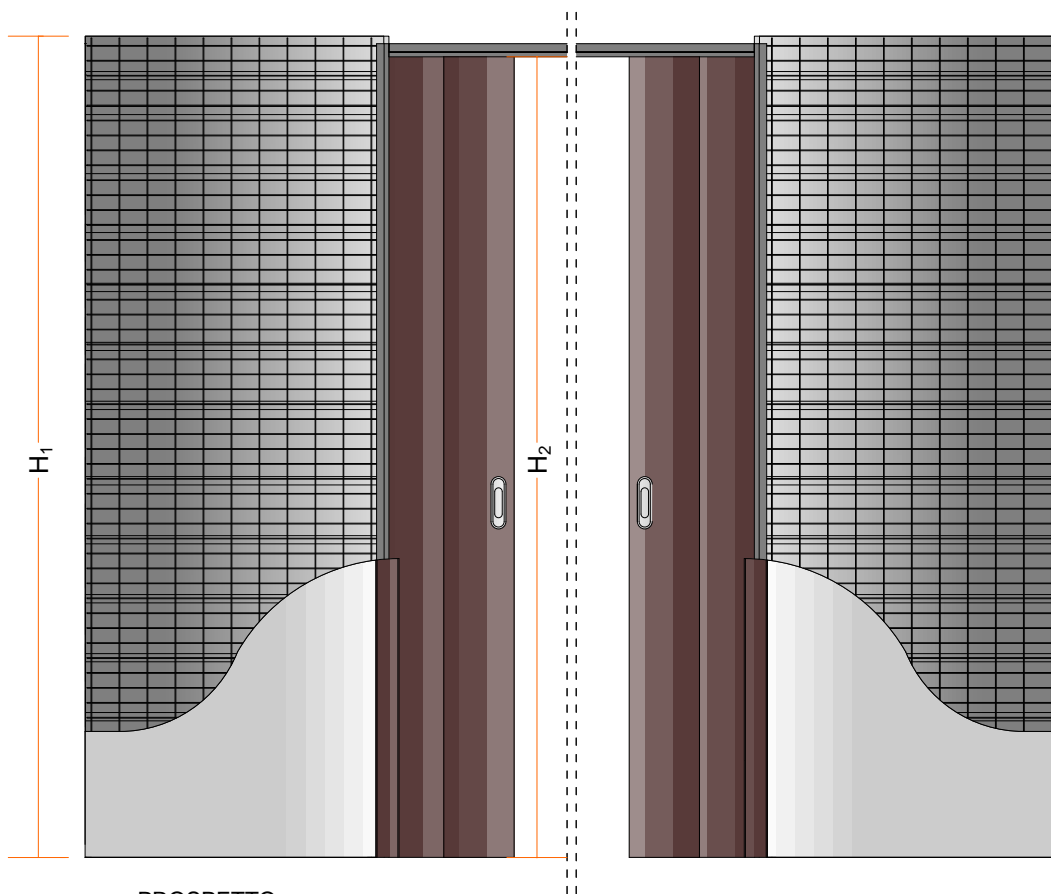
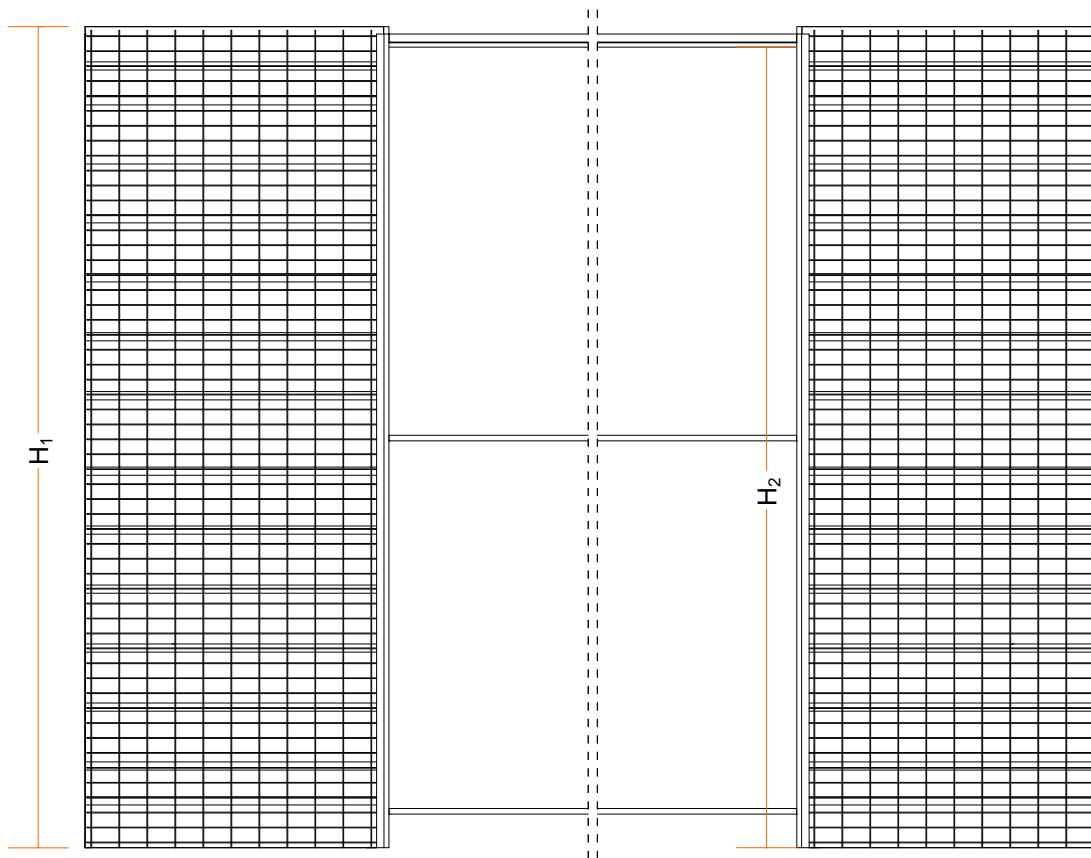

PROSPETTO

S_e	S_i
175	139

S_e = Spessore Parete Finita
 S_i = Sede interna

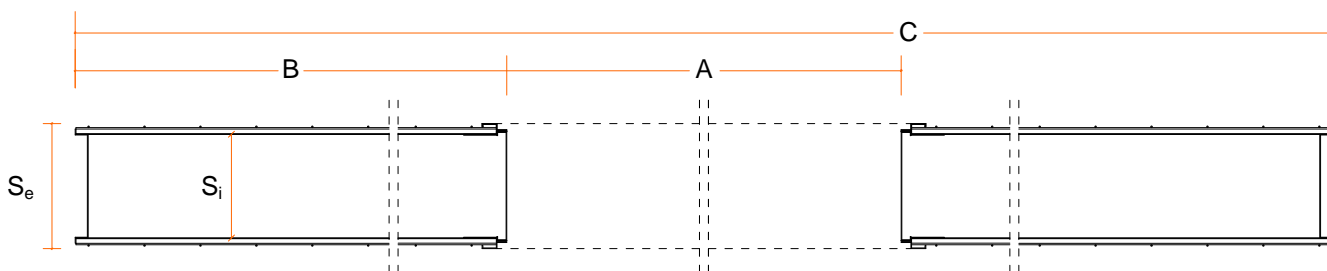

SEZIONE ORIZZONTALE

COD.	A	B	C	H_1	H_2	Misura porta LxH
E 60x210/200/202 SV D	2430	615	3660	2200/2100/2120	2145/2045/2065	N°4 610x2110/2010/2030
E 70x210/200/202 SV D	2830	715	4260	2200/2100/2120	2145/2045/2065	N°4 710x2110/2010/2030
E 80x210/200/202 SV D	3230	815	4860	2200/2100/2120	2145/2045/2065	N°4 810x2110/2010/2030
E 90x210/200/202 SV D	3630	915	5460	2200/2100/2120	2145/2045/2065	N°4 910x2110/2010/2030
E 100x210/200/202 SV D	4030	1015	6060	2200/2100/2120	2145/2045/2065	N°4 1010x2110/2010/2030
E 110x210/200/202 SV D	4430	1115	6660	2200/2100/2120	2145/2045/2065	N°4 1110x2110/2010/2030
E 120x210/200/202 SV D	4830	1215	7260	2200/2100/2120	2145/2045/2065	N°4 1210x2110/2010/2030

A = Luce Lorda ; B = Larghezza Controtelaio; C = Larghezza Complessiva; H_1 = Altezza Controtelaio; H_2 = Altezza Lorda.