

# EUROCASSONETTO A DUE ANTE CENTRALI versione cartongesso

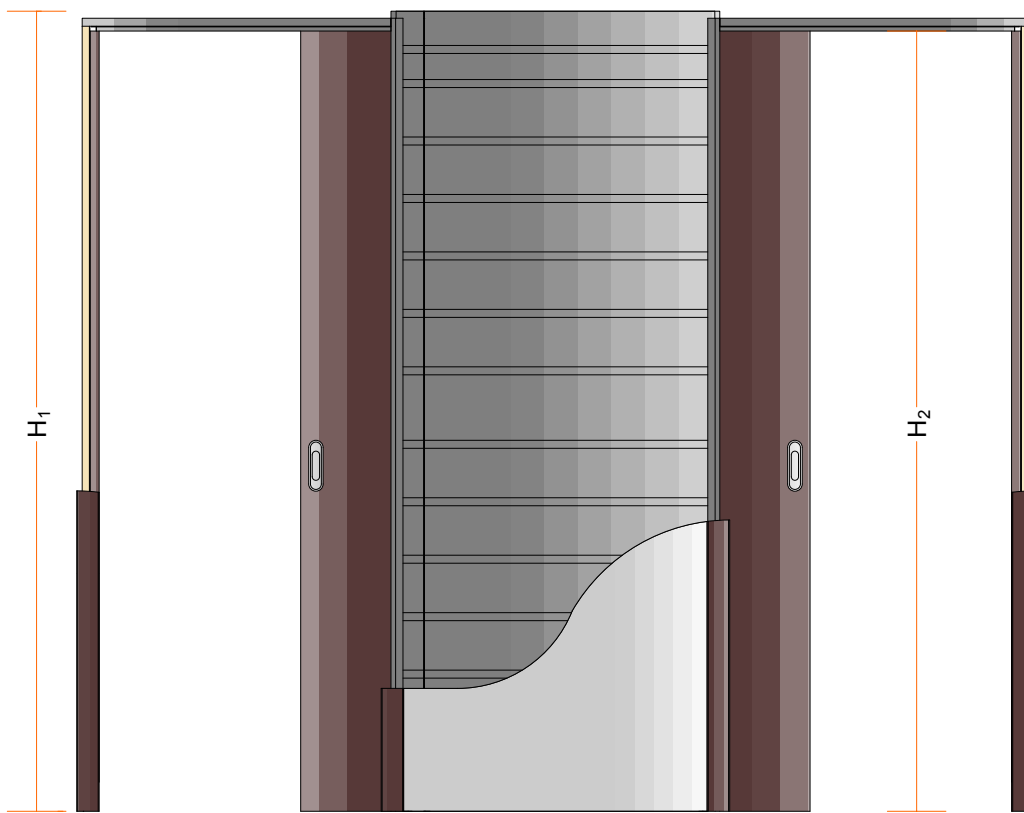

PROSPETTO

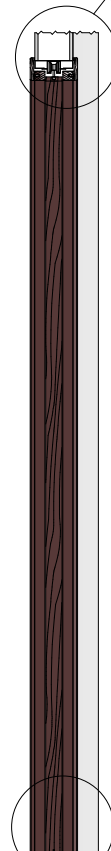
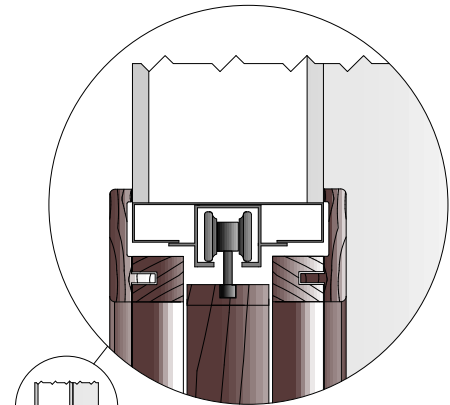

SEZIONE VERTICALE

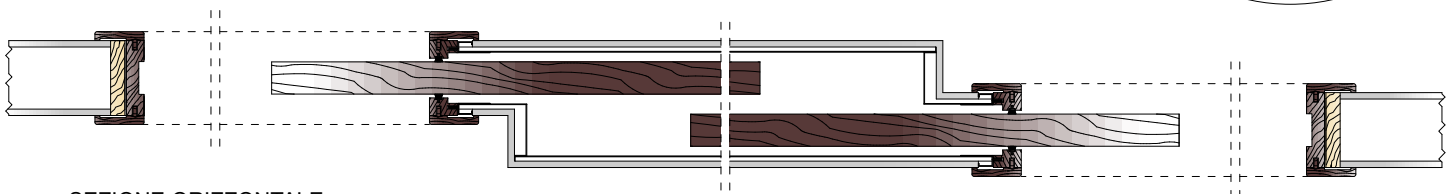
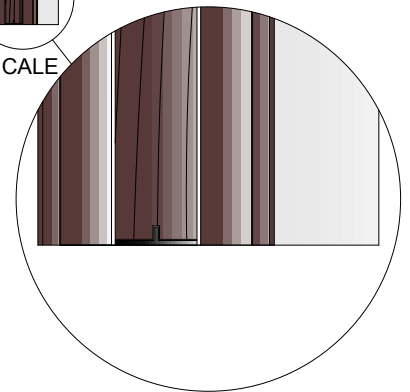

SEZIONE ORIZZONTALE

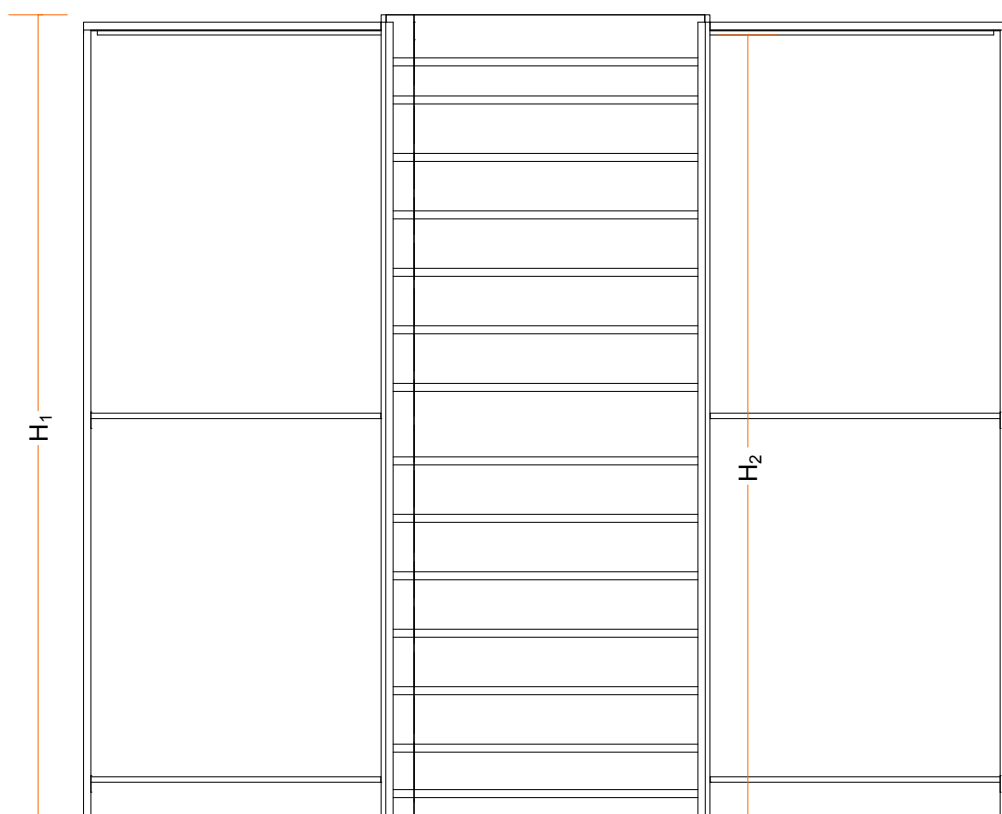

PROSPETTO

|       |       |
|-------|-------|
| $S_e$ | $S_i$ |
| 175   | 69    |

$S_e$  = Spessore Parete Finita  
 $S_i$  = Sede interna

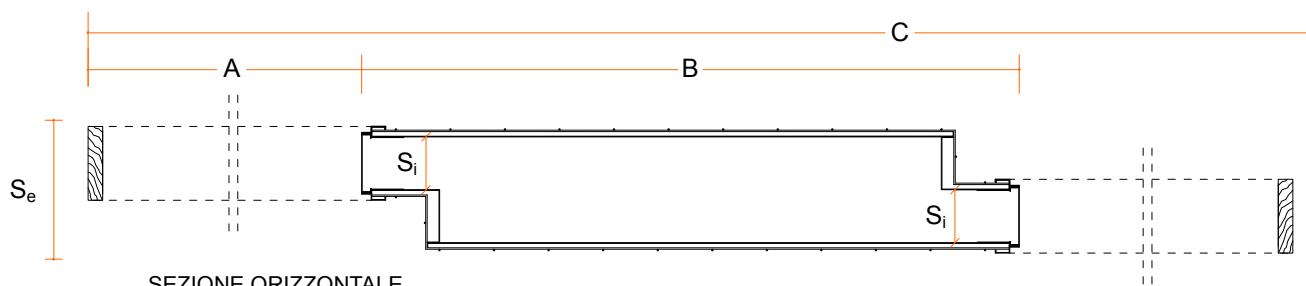

SEZIONE ORIZZONTALE

| COD.                                | A    | B    | C    | $H_1$          | $H_2$          | Misura porta<br>LxH     |
|-------------------------------------|------|------|------|----------------|----------------|-------------------------|
| E 60x210/200/202 2C CTG. ( $S_e$ )  | 645  | 705  | 2035 | 2200/2100/2120 | 2145/2045/2065 | N°2 610x2110/2010/2030  |
| E 70x210/200/202 2C CTG. ( $S_e$ )  | 745  | 805  | 2335 | 2200/2100/2120 | 2145/2045/2065 | N°2 710x2110/2010/2030  |
| E 80x210/200/202 2C CTG. ( $S_e$ )  | 845  | 905  | 2635 | 2200/2100/2120 | 2145/2045/2065 | N°2 810x2110/2010/2030  |
| E 90x210/200/202 2C CTG. ( $S_e$ )  | 945  | 1005 | 2935 | 2200/2100/2120 | 2145/2045/2065 | N°2 910x2110/2010/2030  |
| E 100x210/200/202 2C CTG. ( $S_e$ ) | 1045 | 1105 | 3235 | 2200/2100/2120 | 2145/2045/2065 | N°2 1010x2110/2010/2030 |
| E 110x210/200/202 2C CTG. ( $S_e$ ) | 1145 | 1205 | 3535 | 2200/2100/2120 | 2145/2045/2065 | N°2 1110x2110/2010/2030 |
| E 120x210/200/202 2C CTG. ( $S_e$ ) | 1245 | 1305 | 3835 | 2200/2100/2120 | 2145/2045/2065 | N°2 1210x2110/2010/2030 |

A = Luce Lorda ; B = Larghezza Controtelaio; C = Larghezza Complessiva;  $H_1$  = Altezza Controtelaio;  $H_2$  = Altezza Lorda.